



LOCK /SL

sistema de atenuação acústica



GSK001

PESO 1,003 kg/m
Marco Superior 2 Planos

Jx 37162 mm⁴
Jy 236720 mm⁴
Wx 1850 mm³
Wy 6068 mm³

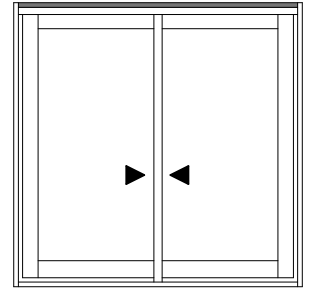
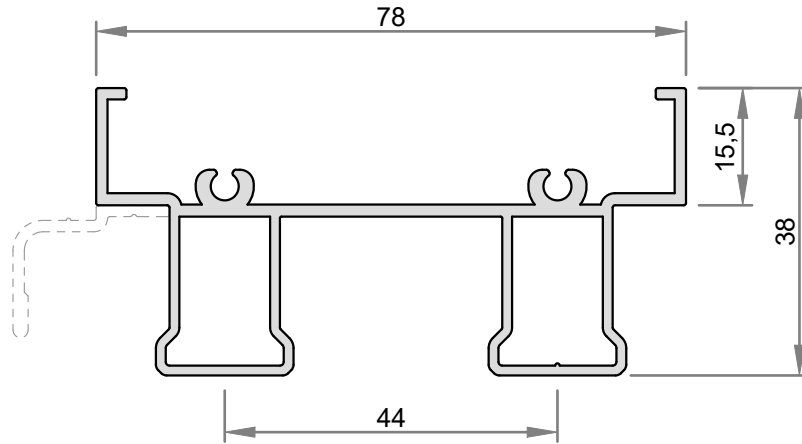

GSK002

PESO 1,203 kg/m
Marco Inferior 2 Planos

Jx 25573 mm⁴
Jy 260824 mm⁴
Wx 1562 mm³
Wy 6639 mm³

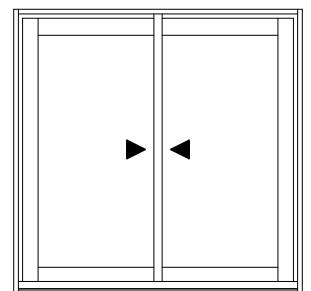
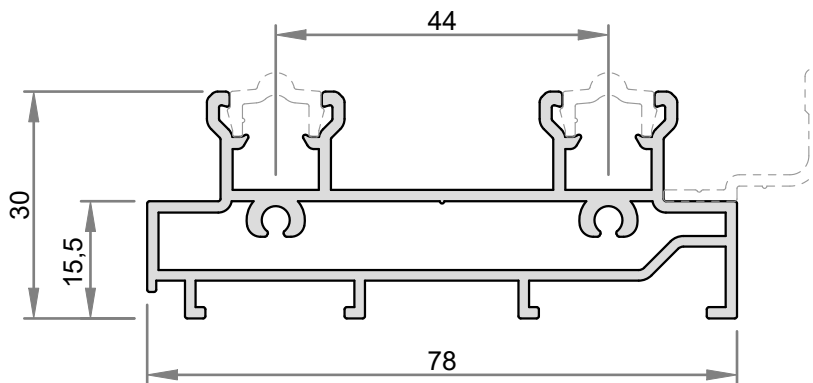

GSK031

PESO 0,588 kg/m
Complemento Marco
Superior para 2 Planos

Jx 3616 mm⁴
Jy 155830 mm⁴
Wx 221 mm³
Wy 3624 mm³

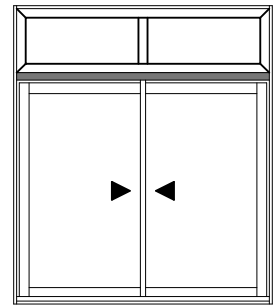
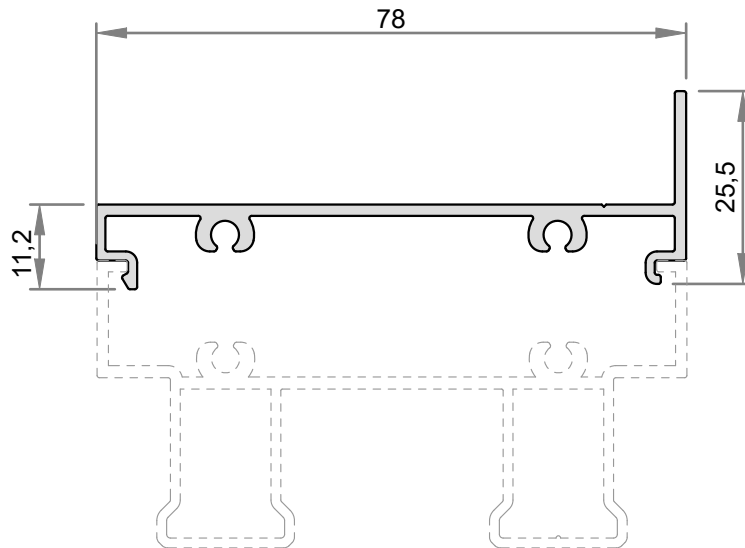

GSK032

PESO 0,605 kg/m
Complemento Marco
Inferior para 2 Planos

Jx 3937 mm⁴
Jy 163235 mm⁴
Wx 238 mm³
Wy 3930 mm³

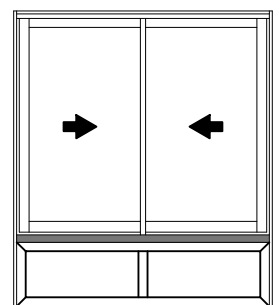
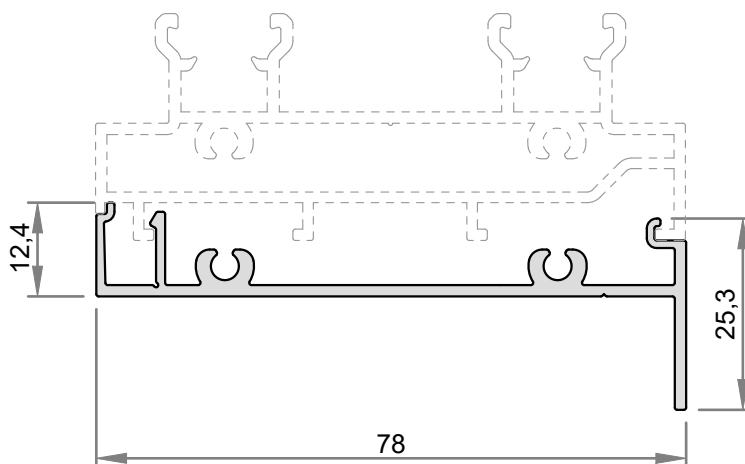

GSK033

PESO 0,621 kg/m
Marco Inferior e
Superior para 2 Planos

Jx 6130 mm⁴
Jy 178518 mm⁴
Wx 356 mm³
Wy 4177 mm³

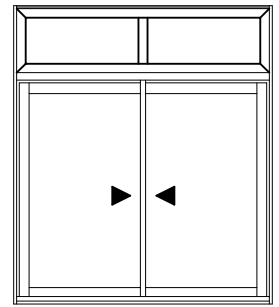
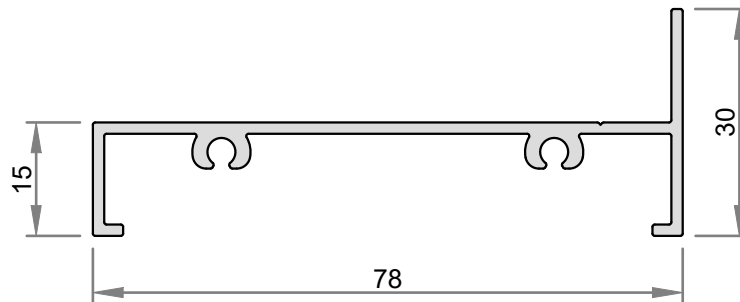

GSK003

PESO 0,470 kg/m
Marco Lateral para 2 Planos

Jx 132586 mm⁴
Jy 3271 mm⁴
Wx 3397 mm³
Wy 276 mm³

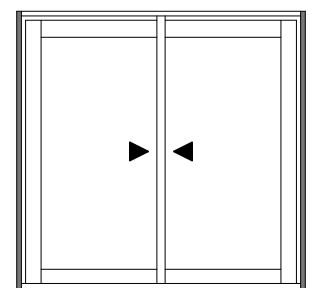
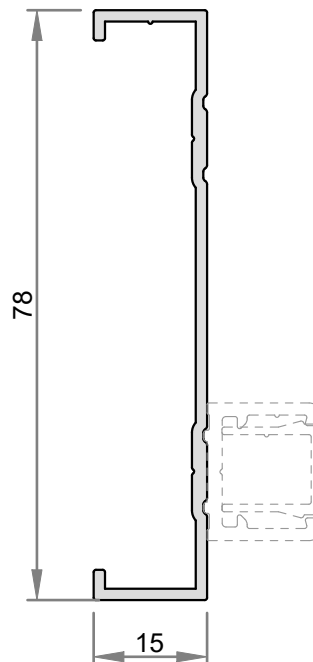

GSK013

PESO 1,521 kg/m
Marco Superior 3 Planos

Jx 55508 mm⁴
Jy 813515 mm⁴
Wx 2764 mm³
Wy 13172 mm³

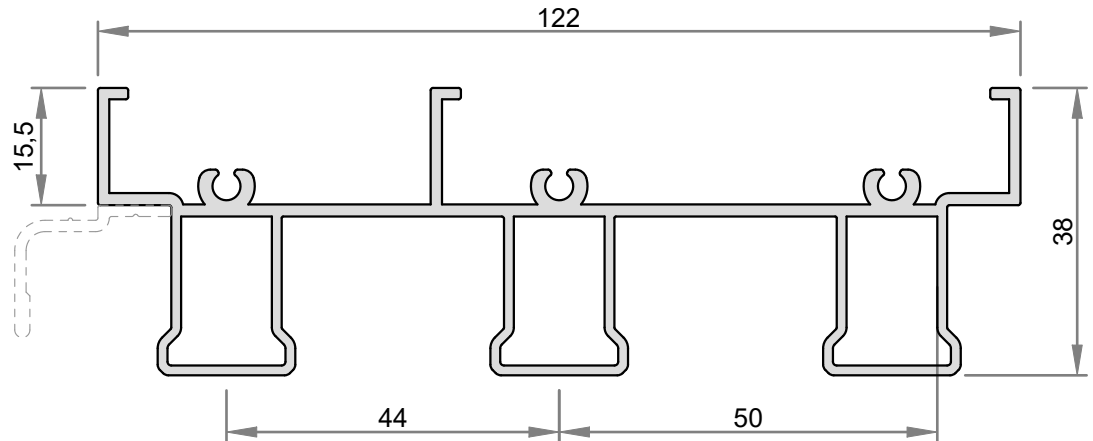

GSK014

PESO 1,820 kg/m
Marco Inferior 3 Planos

Jx 37163 mm⁴
Jy 937104 mm⁴
Wx 2293 mm³
Wy 15300 mm³

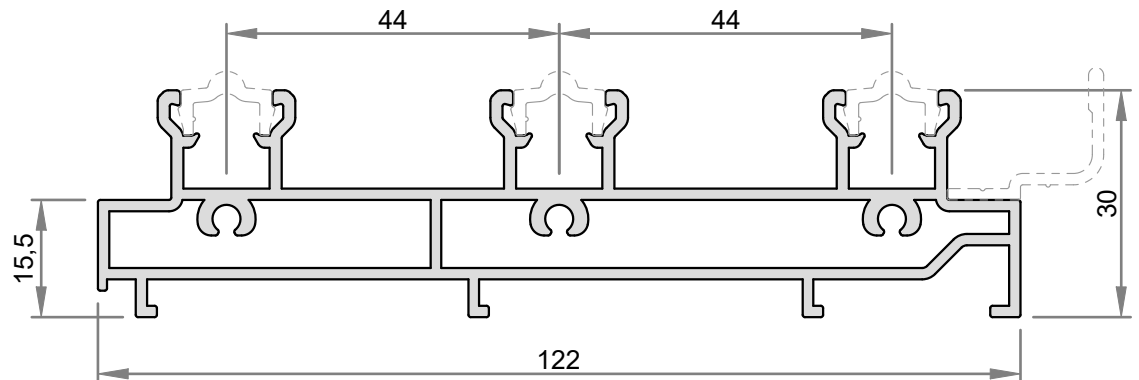

Todas as informações são de propriedades da Olgacolor e estão sujeitas a alterações sem aviso prévio.

GSK015

PESO 0,729 kg/m
Marco Lateral para 3 Planos

Jx 424208 mm⁴

Jy 4978 mm⁴

Wx 6853 mm³

Wy 417 mm³

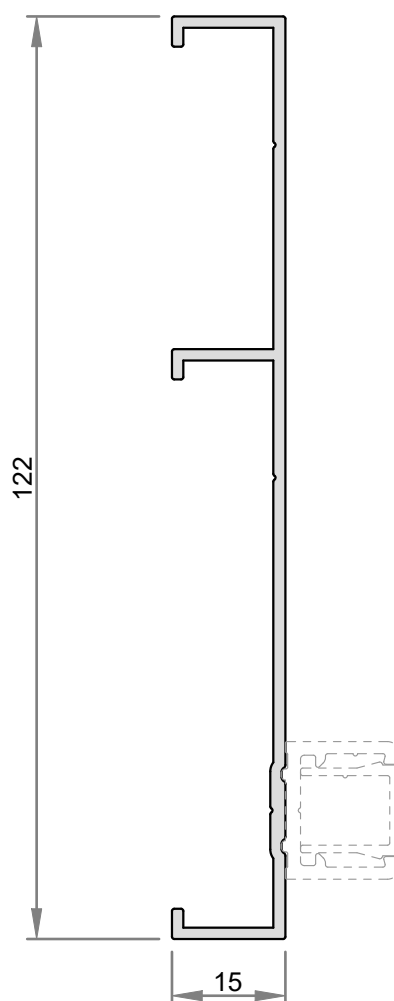
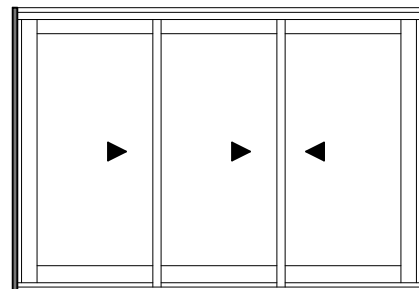

GSK004

PESO 0,236 kg/m
Mata Junta

Jx 4257 mm⁴
Jy 2025 mm⁴
Wx 467 mm³
Wy 211 mm³

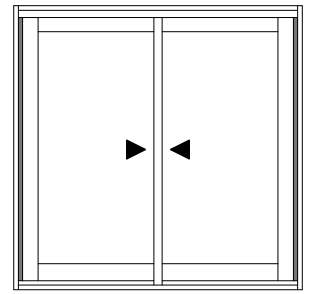
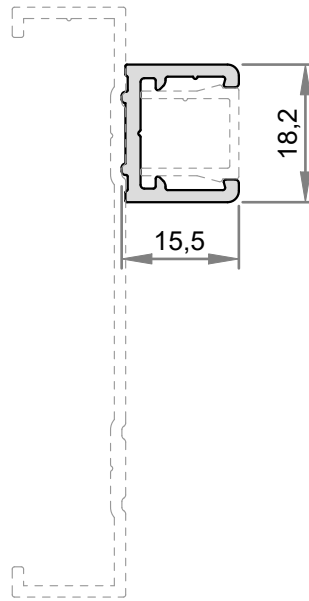

GSK012

PESO 0,345 kg/m
Mata Junta Central

Jx 9865 mm⁴
Jy 3874 mm⁴
Wx 731 mm³
Wy 324 mm³

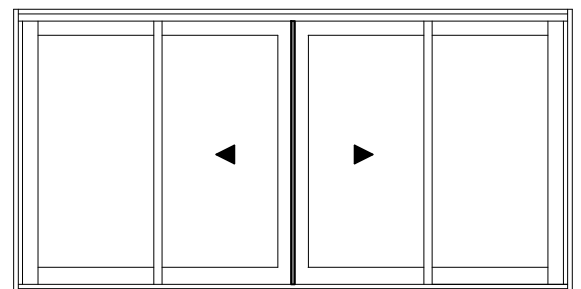
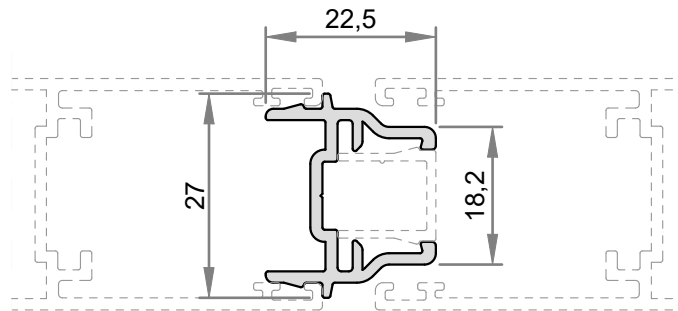

GSK005

PESO 0,113 kg/m
Tampa de Acabamento

Jx 917 mm⁴
Jy 661 mm⁴
Wx 143 mm³
Wy 78 mm³

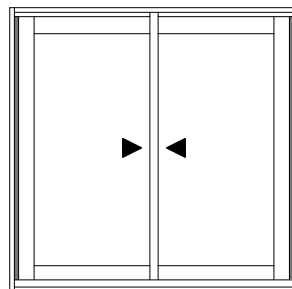
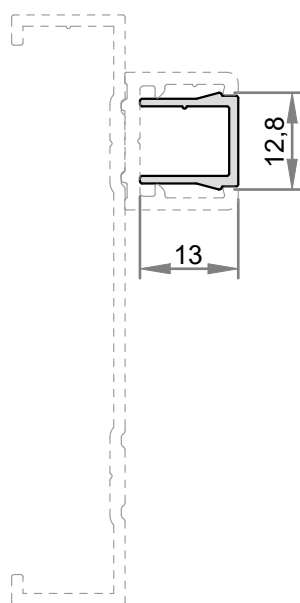

GSK006

PESO 0,148 kg/m
Pingadeira e Barreira
de Condensação

Jx 1512 mm⁴
Jy 2274 mm⁴
Wx 128 mm³
Wy 162 mm³

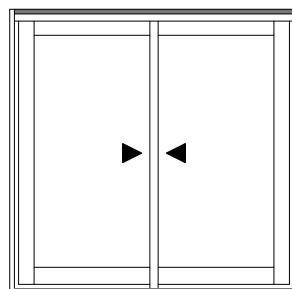
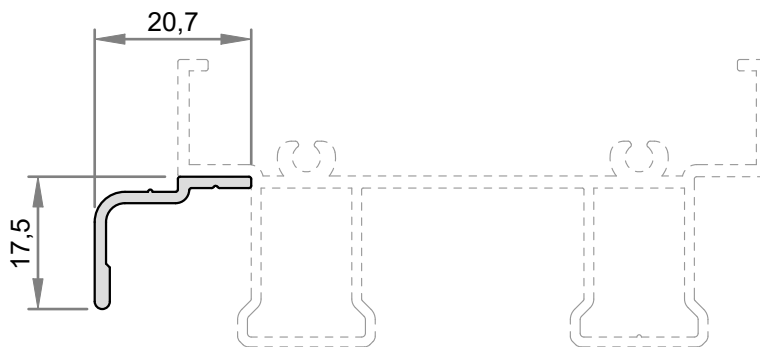

Todas as informações são de propriedades da Olgacolor e estão sujeitas a alterações sem aviso prévio.

GSK007

PESO 0,111 kg/m
Trilho Individual

Jx 169 mm⁴
Jy 646 mm⁴
Wx 36 mm³
Wy 101 mm³

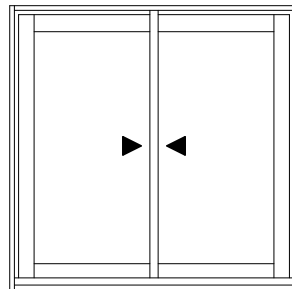
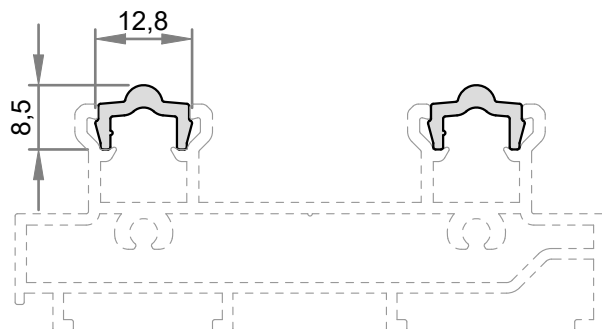

GSK011

PESO 0,211 kg/m
Redutor de Vidro

Jx 3340 mm⁴
Jy 6214 mm⁴
Wx 346 mm³
Wy 467 mm³

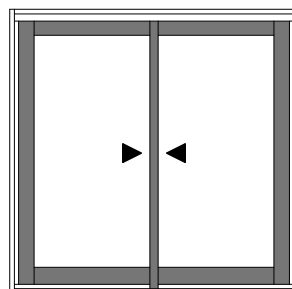
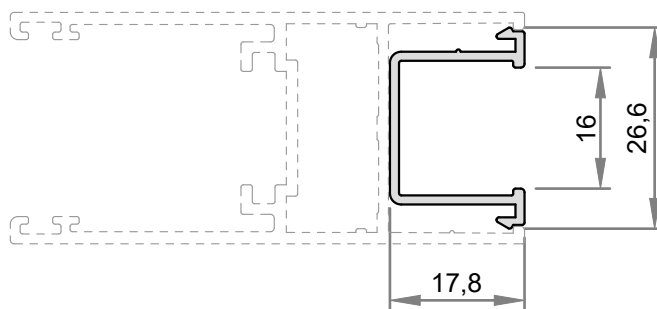

Todas as informações são de propriedades da Olgacolor e estão sujeitas a alterações sem aviso prévio.

GSK008

PESO 0,895 kg/m
Montante Lateral, Central, Mão de Amigo e Travessa

Jx 54342 mm⁴
Jy 103104 mm⁴
Wx 3551 mm³
Wy 2975 mm³

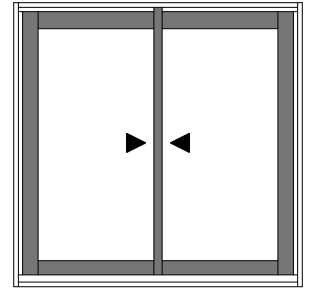
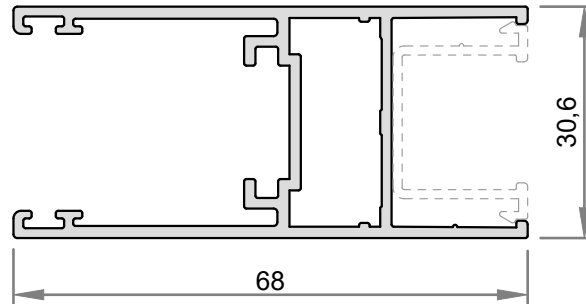

GSK016

PESO 1,377 kg/m
Montante Lateral, Central
e Mão de Amigo

Jx 252009 mm⁴
Jy 126321 mm⁴
Wx 5443 mm³
Wy 3366 mm³

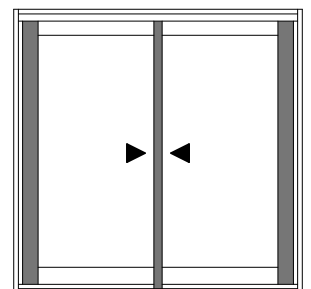
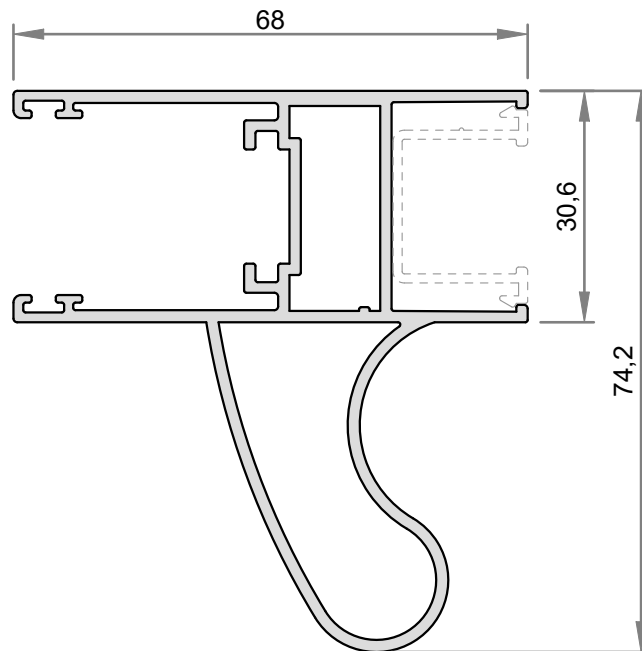

GSK009

PESO 0,758 kg/m
Montante Mão de Amigo 90°

Jx 66294 mm⁴
Jy 53334 mm⁴
Wx 3159 mm³
Wy 1963 mm³

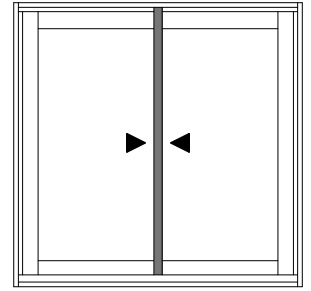
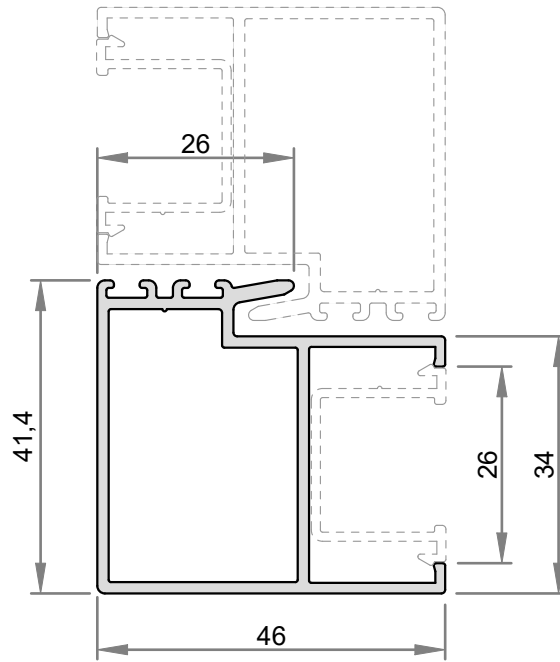

GSK010

PESO 1,217 kg/m
Montante Mão de Amigo 90°

Jx 299413 mm⁴
Jy 68992 mm⁴
Wx 6236 mm³
Wy 2484 mm³

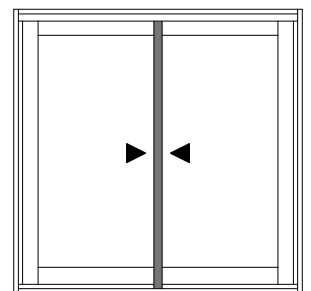
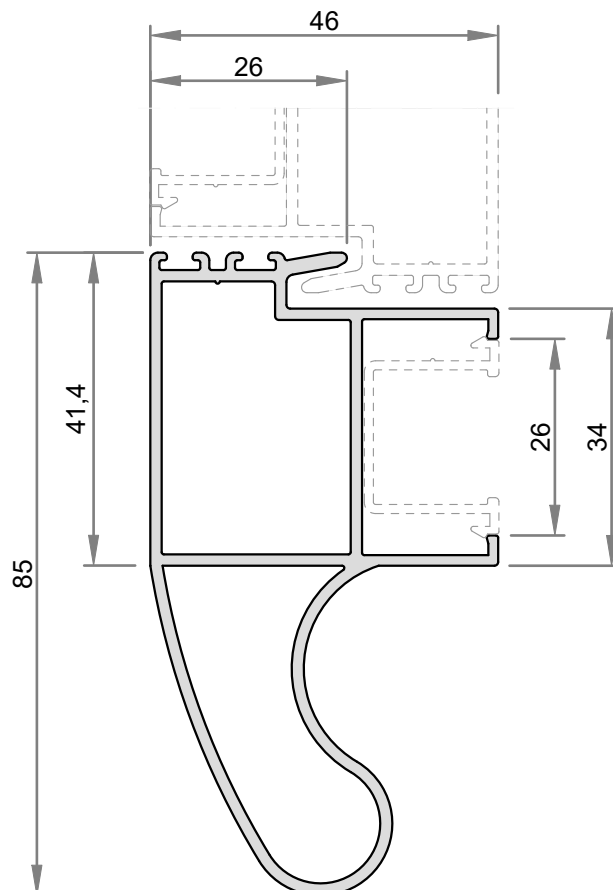

GSK021

PESO 0,767 kg/m
Travessa Intermediária

Jx 54222 mm⁴
Jy 39245 mm⁴
Wx 1936 mm³
Wy 2565 mm³

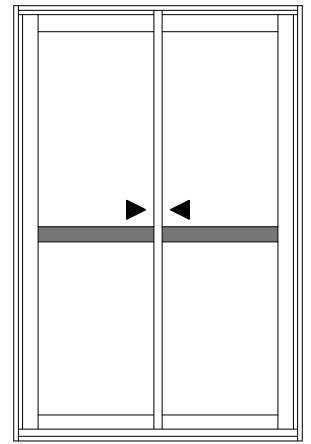
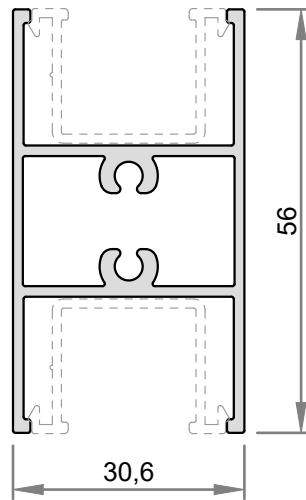

GSK017

PESO 0,577 kg/m
Mão de Amigo

Jx 32271 mm⁴
Jy 53112 mm⁴
Wx 1149 mm³
Wy 1480 mm³

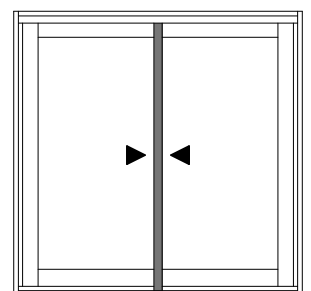
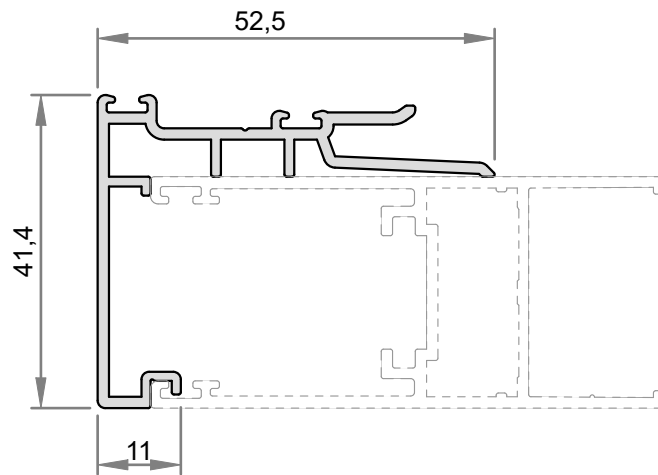

Todas as informações são de propriedades da Olgacolor e estão sujeitas a alterações sem aviso prévio.

GSK024

PESO 0,946 kg/m
Travessa / Montante

Jx 56789 mm⁴

Jy 119686 mm⁴

Wx 3711 mm³

Wy 3299 mm³

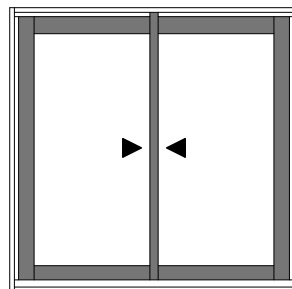
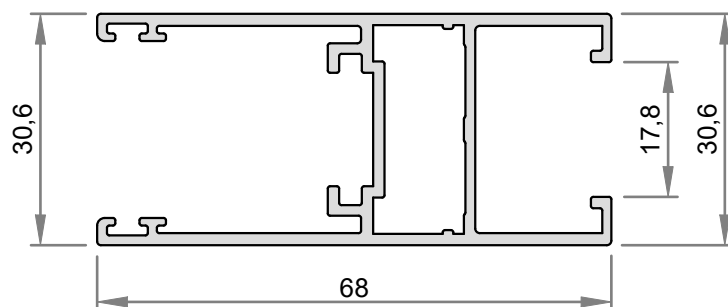

GSK022

PESO 1,749 kg/m
Montante Lateral
e Central

Jx 536612 mm⁴

Jy 172747 mm⁴

Wx 10006 mm³

Wy 4110 mm³

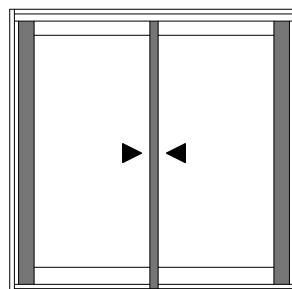
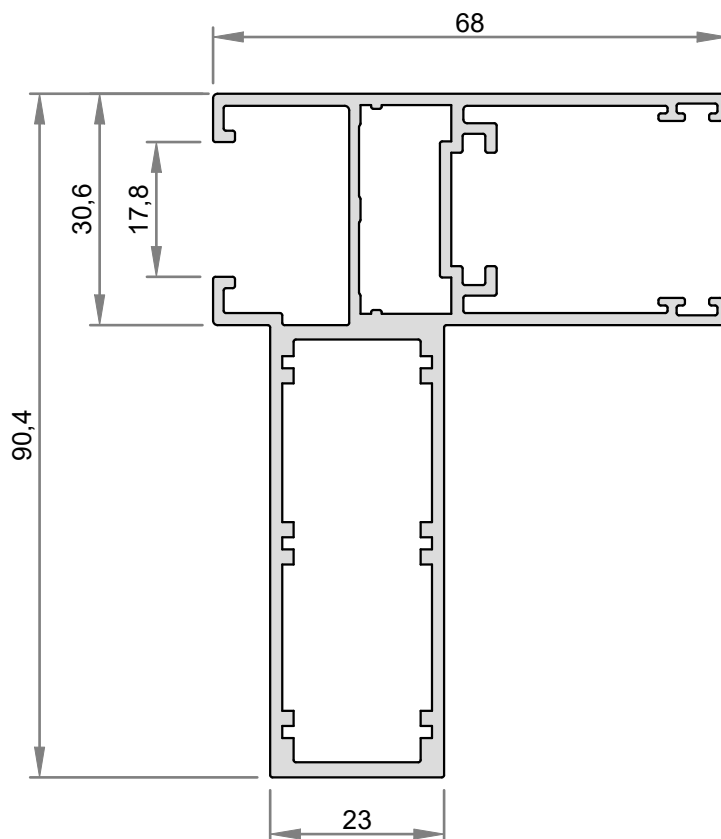

GSK023

PESO 1,576 kg/m
Montante Lateral
e Central

Jx 289525 mm⁴
Jy 161984 mm⁴
Wx 7145 mm³
Wy 3925 mm³

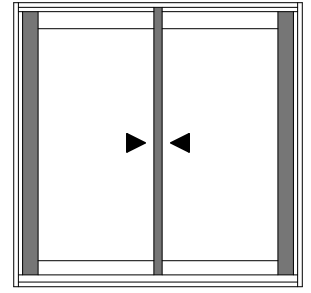
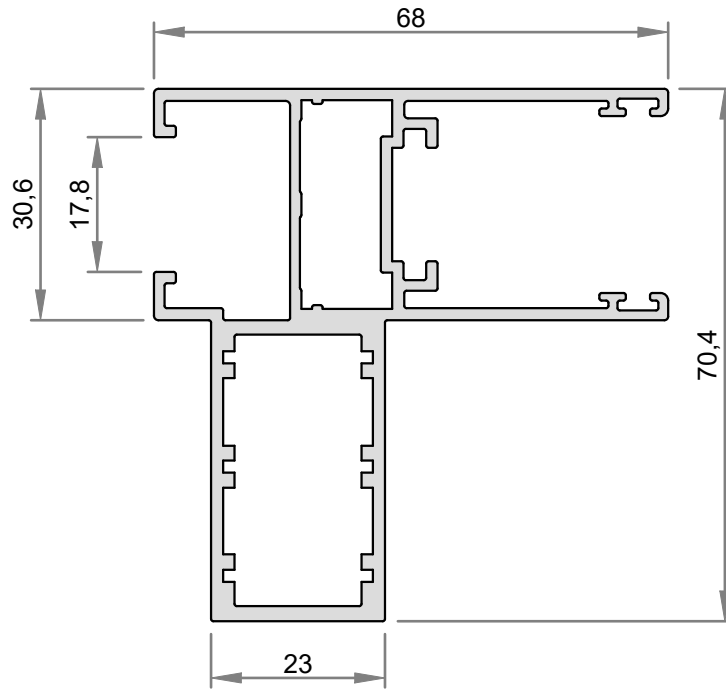

GSK027

PESO 0,928 kg/m
Montante Mão de
amigo Minimalista

Jx 128014 mm⁴
Jy 22340 mm⁴
Wx 3922 mm³
Wy 1676 mm³

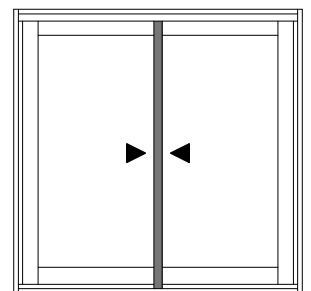
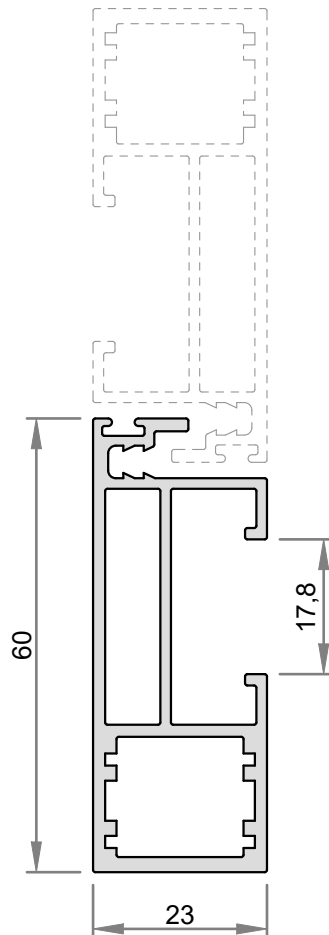

GSK026

PESO 1,241 kg/m
Montante Mão de amigo
Minimalista

Jx 310260 mm
Jy 32273 mm
Wx 6971 mm
Wy 2508 mm

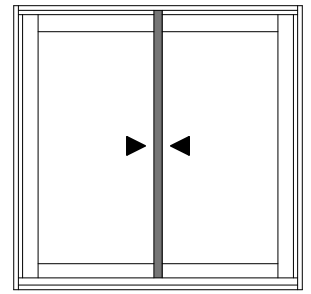
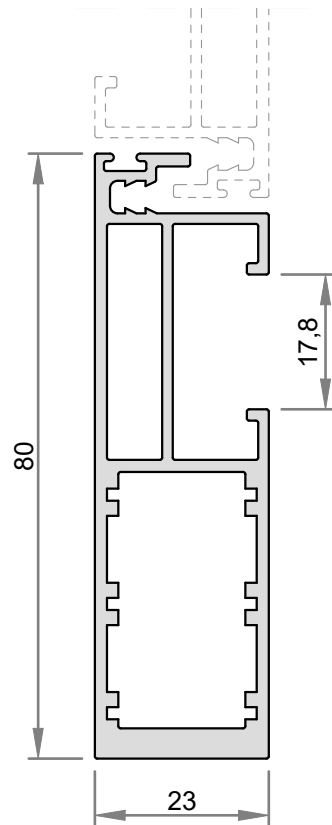

GSK025

PESO 1,415 kg/m
Mão de Amigo Minimalista

Jx 557958 mm⁴
Jy 39719 mm⁴
Wx 10390 mm³
Wy 3127 mm³

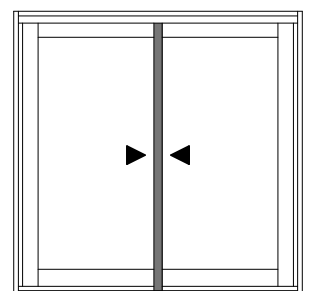
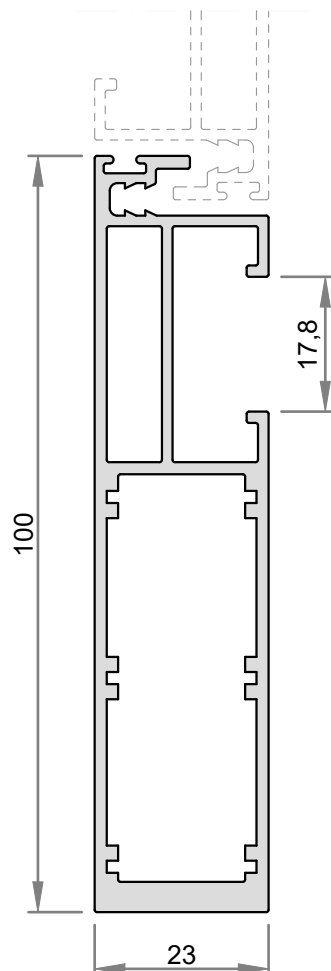

GSK040

PESO 1,126 kg/m
Marco Superior 2 Planos para Vidro Colado

Jx 27259 mm⁴
Jy 450077 mm⁴
Wx 1581 mm³
Wy 8251 mm³

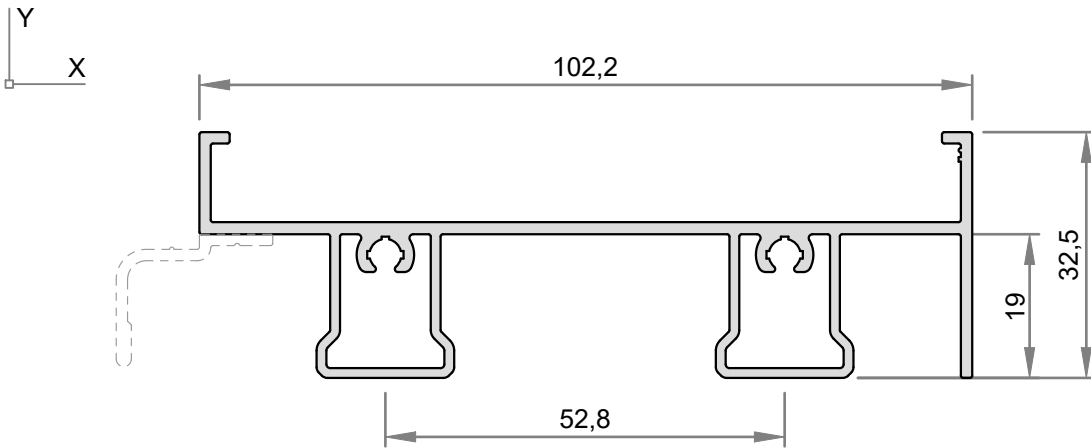
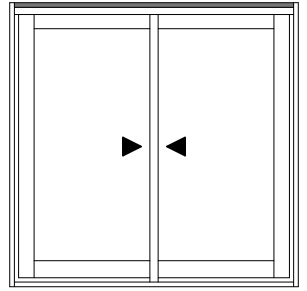

GSK041

PESO 1,503 kg/m
Marco Inferior 2 Planos para Vidro Colado

Jx 35108 mm⁴
Jy 568153 mm⁴
Wx 1783 mm³
Wy 10587 mm³

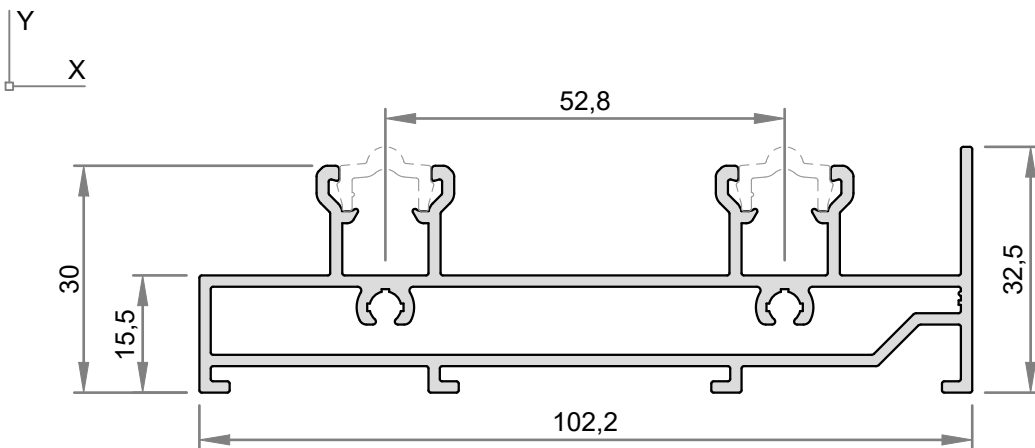
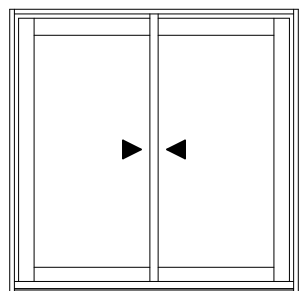

GSK042

PESO 0,545 kg/m
Marco Lateral

Jx 254034 mm⁴
Jy 3463 mm⁴
Wx 4964 mm³
Wy 283 mm³

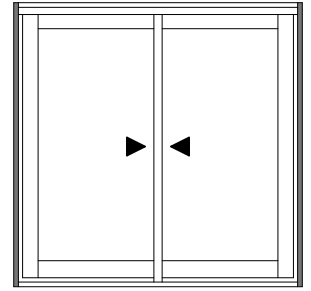
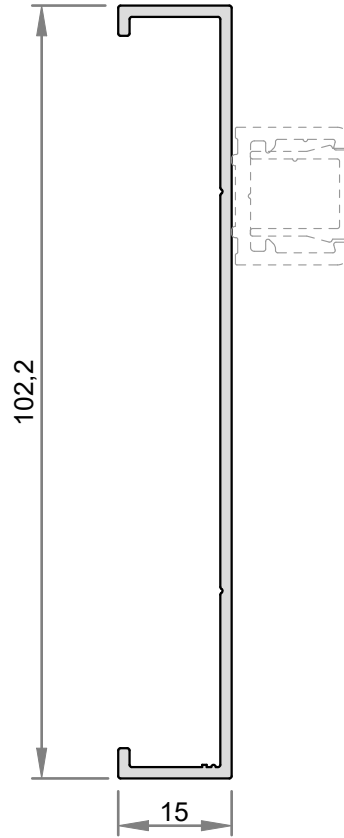

GSK043

PESO 0,854 kg/m
Travessa / Montante

Jx 51431 mm⁴
Jy 94765 mm⁴
Wx 2285 mm³
Wy 3041 mm³

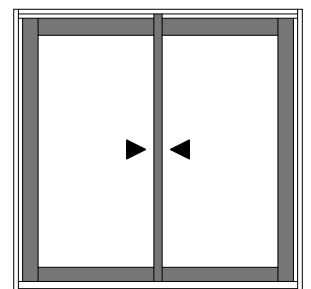
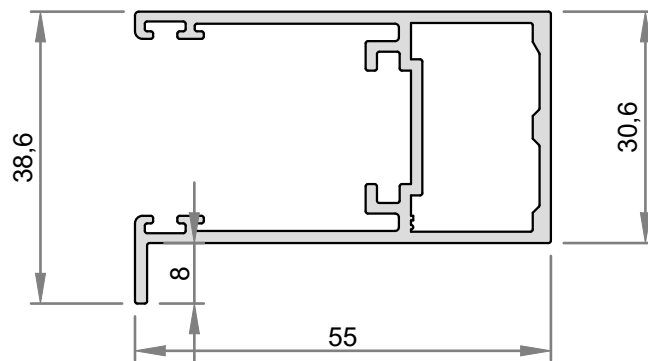

GSK046

PESO 0,174 kg/m
Tampa de Acabamento Reforço Montante

Jx 254 mm⁴
Jy 3272 mm⁴
Wx 52 mm³
Wy 284 mm³

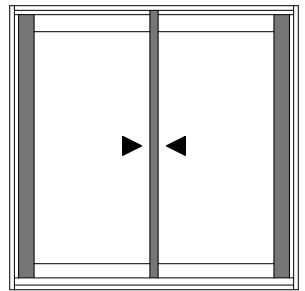
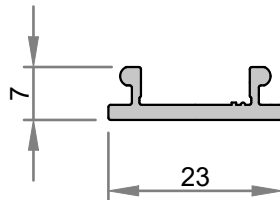

GSK047

PESO 1,262 kg/m
Reforço para Montante

Jx 149267 mm⁴
Jy 35819 mm⁴
Wx 4572 mm³
Wy 3113 mm³

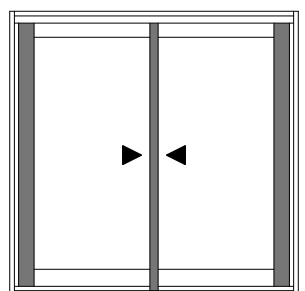
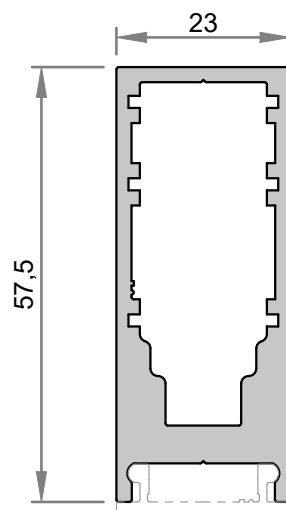

GSK044

PESO 0,456 kg/m
Mão de Amigo Interna

Jx 29622 mm⁴
Jy 11445 mm⁴
Wx 991 mm³
Wy 622 mm³

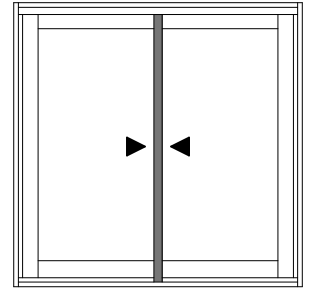
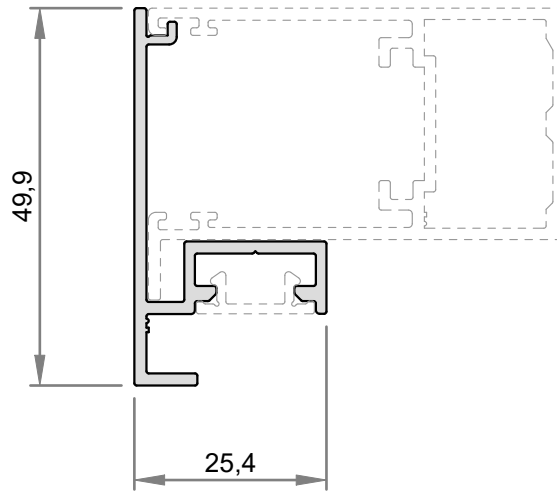

GSK045

PESO 0,611 kg/m
Mão de Amigo Externa

Jx 35916 mm⁴
Jy 72882 mm⁴
Wx 1022 mm³
Wy 1943 mm³

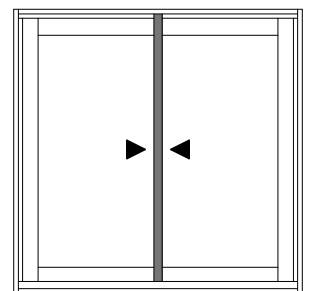
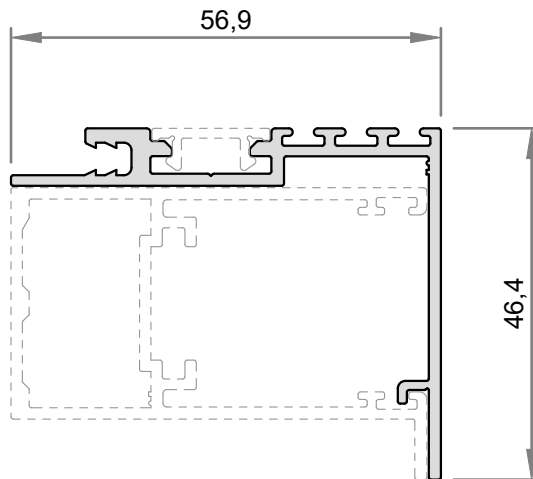

Todas as informações são de propriedades da Olgacolor e estão sujeitas a alterações sem aviso prévio.

GSK410

PESO 0,087 kg/m
Tampa Mão de Amigo

Jx 79 mm⁴
Jy 686 mm⁴
Wx 21 mm
Wy 88 mm

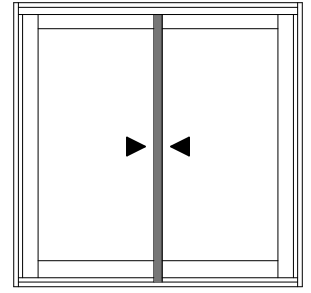
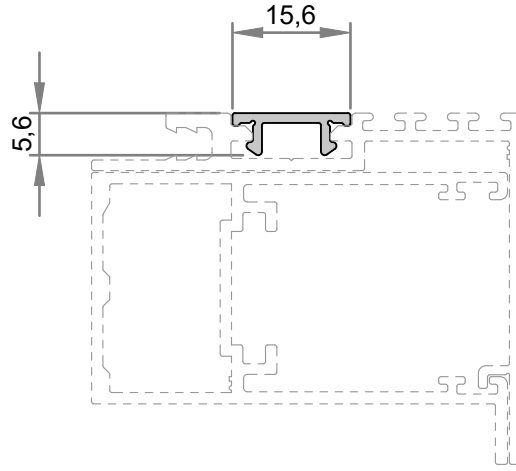

GSK050

PESO 1,661 kg/m
Marco Superior 3 Planos para Vidro Colado

Jx 37186mm⁴

Jy 1465707mm⁴

Wx 2147mm³

Wy 18081mm³

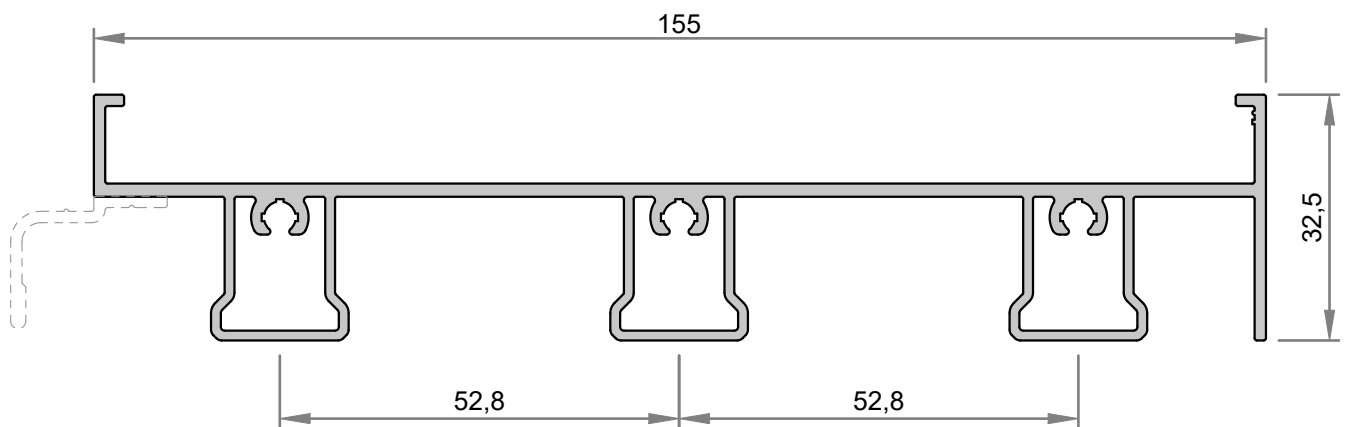
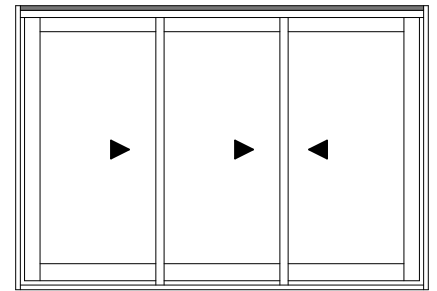

Todas as informações são de propriedades da Olgacolor e estão sujeitas a alterações sem aviso prévio.

GSK051

PESO 2,288 kg/m
Marco Inferior 3 Planos para Vidro Colado

Jx 50195 mm⁴

Jy 1910173 mm⁴

Wx 2542 mm³

Wy 23837 mm³

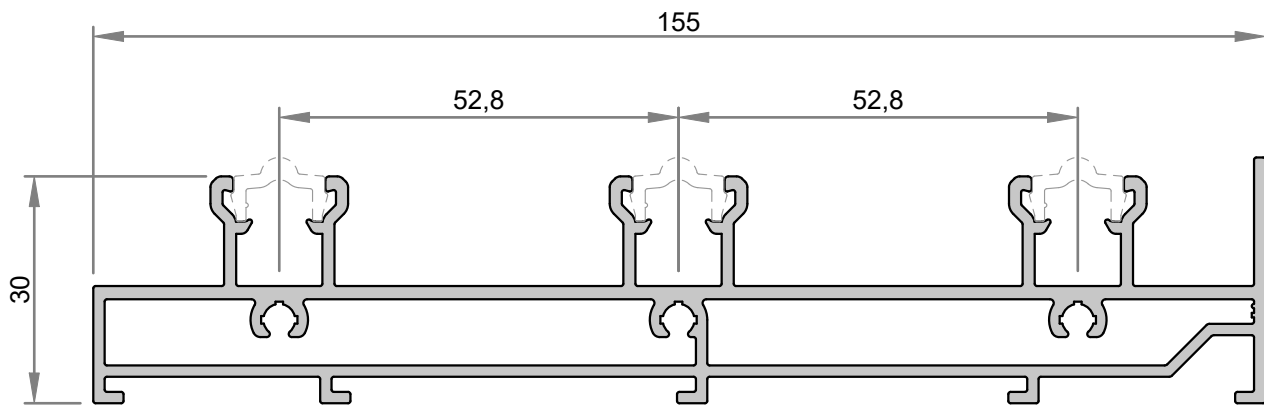
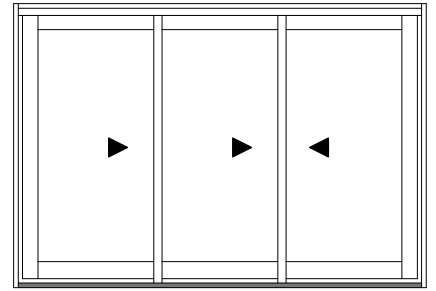

GSK052

PESO 0,927 kg/m
Marco Lateral 3 Planos para Vidro Colado

Jx 833844 mm⁴

Jy 5248 mm⁴

Wx 10511 mm³

Wy 424 mm³

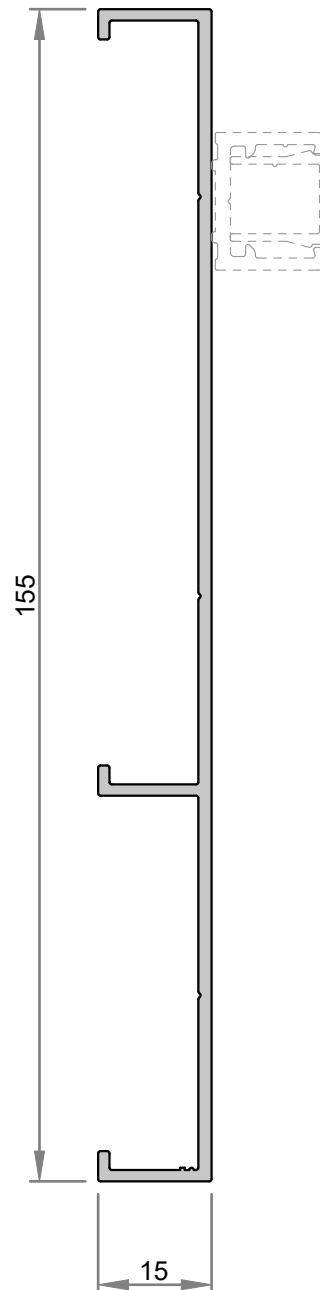
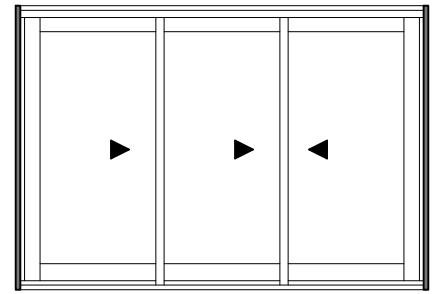

CORRER 02 FOLHAS

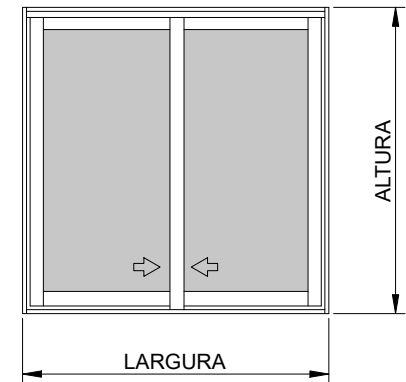

ELEVAÇÃO VISTA EXTERNA
SEM ESCALA

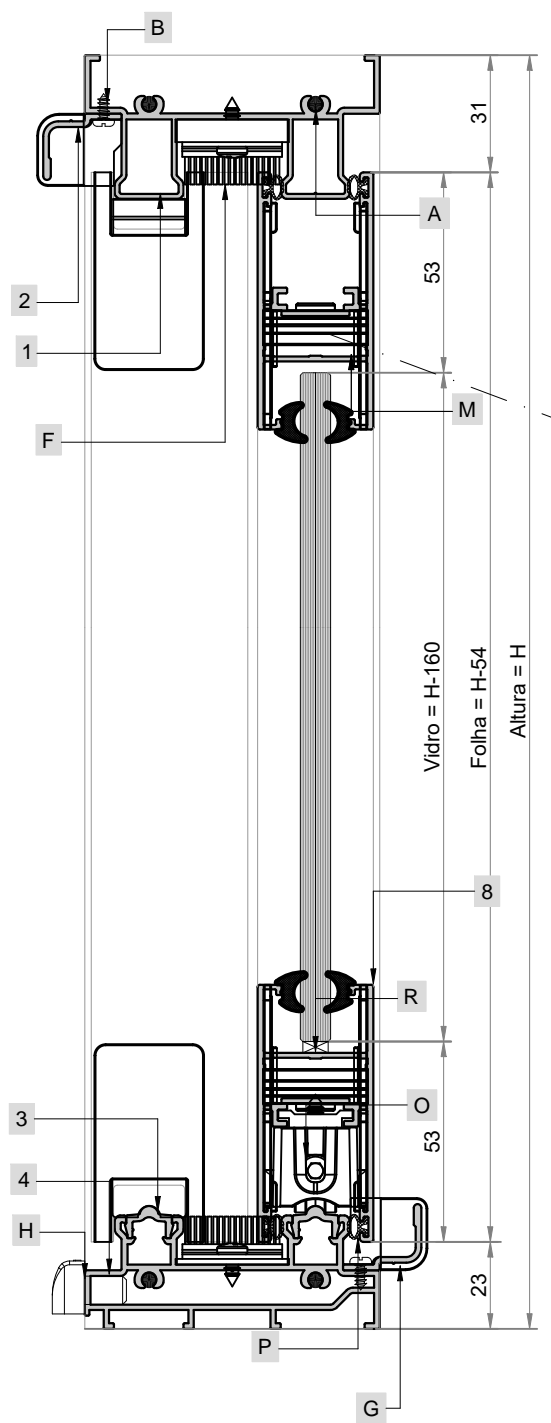

Vidro = H-160
Folha = H-54
Altura = H

Macho que conexão 45°

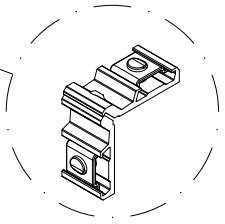

Kit guia deslizante

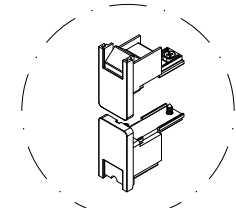

Largura = L

Marco = L-30

Folha = ((L+16)/2)

Vidro = ((L-195)/2)

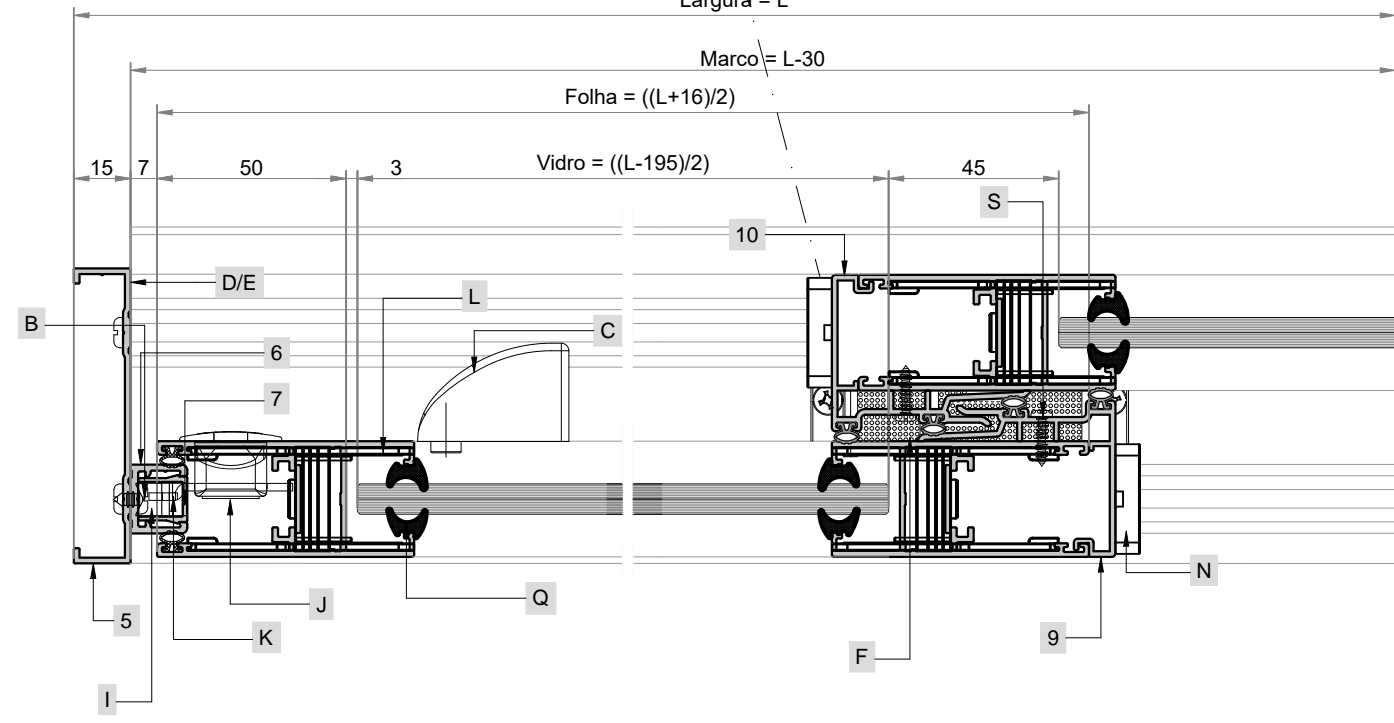

CORRER 02 FOLHAS CONVENCIONAL

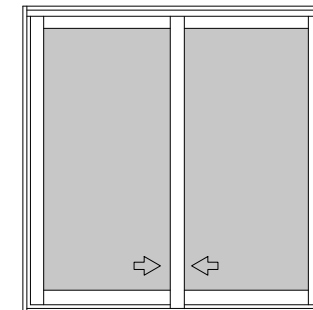

LISTA DE CORTE

POS.	ÍCONE	CÓDIGO	DESCRIÇÃO	ANGULO	DIREÇÃO	QUANT.	FÓRMULA
1		GSK001	Marco superior	90/90°	L	01	L-30
2		GSK006	Pingadeira e barreira de condensação	90/90°	L	02	L-36
3		GSK007	Trilho	90/90°	L	02	L-34
4		GSK002	Marco inferior	90/90°	L	01	L-30
5		GSK003	Marco lateral	90/90°	H	02	H
6		GSK004	Mata junta lateral	90/90°	H	02	H-68
7		GSK005	Tampa de acabamento	90/90°	H	02	H-68
8		GSK024	Travessa superior e inferior	45/45°	L	04	((L+16)/2)
9		GSK024	Montante lateral e mão de amigo	45/45°	H	04	H-54
10		GSK017	Mão de amigo	90/90°	H	02	H-54

ROLDANAS

CÓDIGO OLGA	CARGA	COR
OLG-ROL0001-001	40KG	S/A
OLG-ROL0002-001	80KG	S/A
OLG-ROL0003-001	200KG	S/A

LISTA DE COMPONENTES

POS.	ÍCONE	CÓDIGO OLGA	DESCRIÇÃO	FÓRMULA	UN.
A		OLG-PAR0036	Parafuso autoatarraxante cabeça panela phillips 4,8x32mm - Inox	08	PÇ
B		OLG-PAR0010	Parafuso autoatarraxante cabeça panela phillips 3,9 x 6,5 mm - Inox	((L*2+H*2)/250)	PÇ
C		OLG-NYL0031	Batedeira universal	04	PÇ
D		OLG-VED001	Junta de vedação marco superior	02	PÇ
E		OLG-VED001	Junta de vedação marco inferior	02	PÇ
F		OLG-NYL0042	Vedação inferior / superior - 03 escovas	02	PÇ
G		OLG-NYL0048	Tampa da pingadeira e barreira de condensação	02	PAR
H		OLG-NYL0034	Dreno com portinhola	01	CJ
I		OLG-FEC0114	Contra fecho	02	PÇ
J		CONSULTAR TABELA	Fecho concha	02	PÇ
K		OLG-FEC0138	Lingueta	02	PÇ
L		OLG-CON0001-PTO	Conexão de alinhamento da folha	16	PÇ
M		OLG-CON0007-NAT	Macho que conexão 45° - 26,6x10	08	PÇ
N		OLG-NYL0003	Kit guia deslizante	02	CJ
O		CONSULTAR TABELA	Roldana	04	PÇ
P		OLG-VED0010-PTO	Guarnição perimetral e mão de amigo	((L*4)+(H*8))	MM
Q		Vide tabela	Guarnição do vidro	((L*4)+(H*8))	MM
R		OLG-VED0016-PTO	Calço de apoio do vidro	04	PÇ
S		OLG-PAR0021	Parafuso autoatarraxante cabeça panela phillips 4,2x 13 mm - Inox	(H*2)/250	PÇ

FECHOS

CÓDIGO OLGA	TIPO	COR
OLG-FEC0001-BCO	SEM CHAVE	BRANCO
OLG-FEC0001-PRA	SEM CHAVE	PRATA
OLG-FEC0001-PTO	SEM CHAVE	PRETO
OLG-FEC0002-BCO	COM CHAVE	BRANCO
OLG-FEC0002-PRA	COM CHAVE	PRATA
OLG-FEC0002-PTO	COM CHAVE	PRETO
OLG-FEC0003-BCO	CEGA	BRANCO
OLG-FEC0003-PRA	CEGA	PRATA
OLG-FEC0003-PTO	CEGA	PRETO
OLG-FEC0004-BCO	SEM CHAVE	BRANCO
OLG-FEC0004-PRA	SEM CHAVE	PRATA
OLG-FEC0004-PTO	SEM CHAVE	PRETO
OLG-FEC0005-BCO	COM CHAVE	BRANCO
OLG-FEC0005-PRA	COM CHAVE	PRATA
OLG-FEC0005-PTO	COM CHAVE	PRETO
OLG-FEC0006-BCO	CEGA	BRANCO
OLG-FEC0006-PRA	CEGA	PRATA
OLG-FEC0006-PTO	CEGA	PRETO

Todas as informações são de propriedades da Olgacolor e estão sujeitas a alterações sem aviso prévio.

CORRER 03 FOLHAS

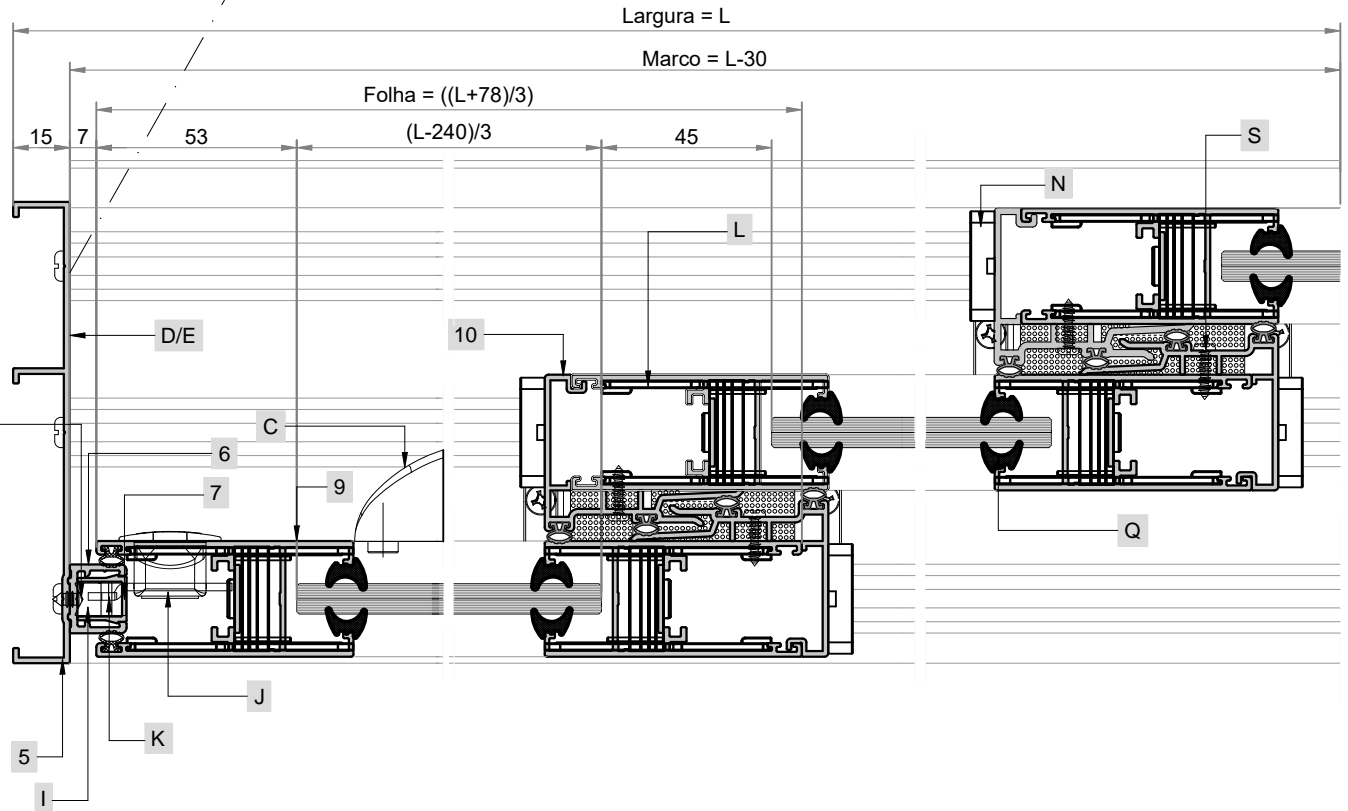
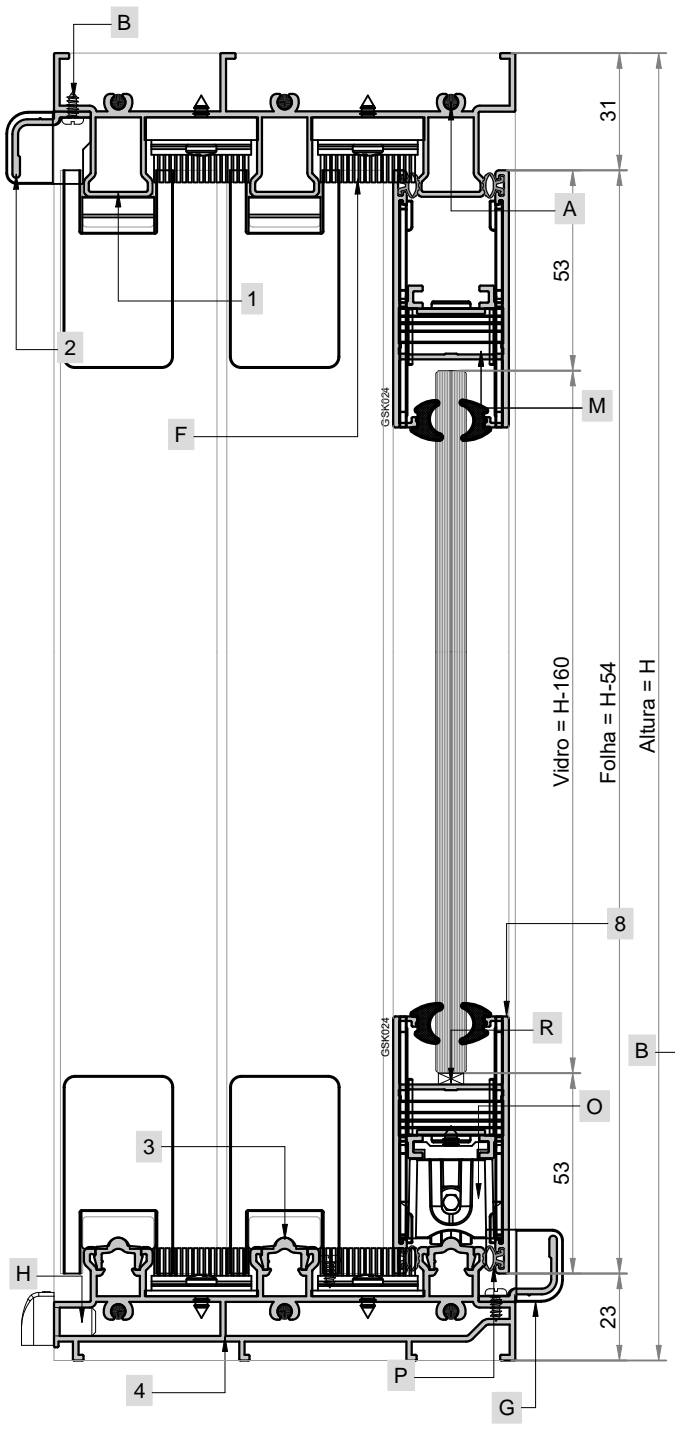
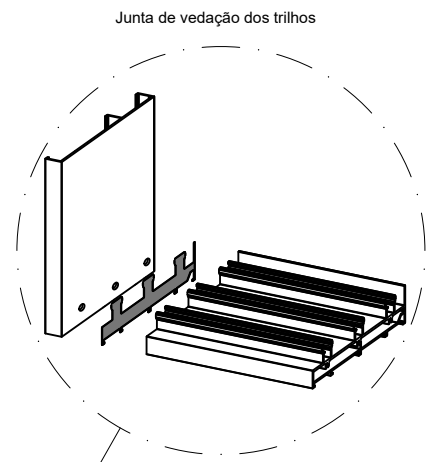
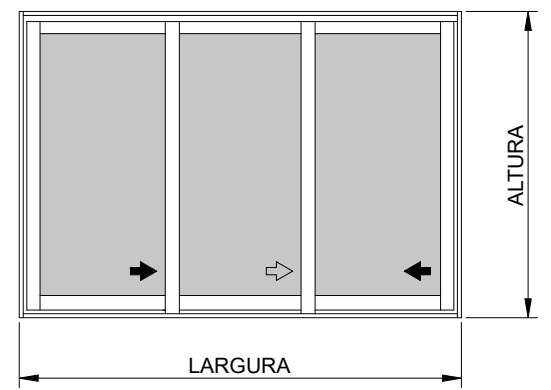

Todas as informações são de propriedades da Olgacolor e estão sujeitas a alterações sem aviso prévio.

CORRER 03 FOLHAS CONVENCIONAL

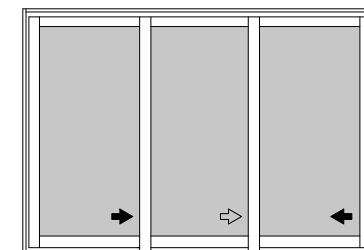

LISTA DE CORTE

POS.	ÍCONE	CÓDIGO	DESCRIÇÃO	ANGULO	DIREÇÃO	QUANT.	FÓRMULA
1		GSK013	Marco superior	90/90°	L	01	L-30
2		GSK006	Pingadeira e barreira de condensação	90/90°	L	02	L-36
3		GSK007	Trilho	90/90°	L	03	L-34
4		GSK014	Marco inferior	90/90°	L	01	L-30
5		GSK015	Marco lateral	90/90°	H	02	H
6		GSK004	Mata junta lateral	90/90°	H	02	H-68
7		GSK005	Tampa de acabamento	90/90°	H	02	H-68
8		GSK024	Travessa superior e inferior	45/45°	L	06	((L+78)/3)
9		GSK024	Montante lateral e mão de amigo	45/45°	H	06	H-54
10		GSK017	Mão de amigo	90/90°	H	04	H-54

ROLDANAS

CÓDIGO OLGA	CARGA	COR
OLG-ROL0001-001	40KG	S/A
OLG-ROL0002-001	80KG	S/A
OLG-ROL0003-001	200KG	S/A

LISTA DE COMPONENTES

POS.	ÍCONE	CÓDIGO OLGA	DESCRIÇÃO	FÓRMULA	UN.
A		OLG-PAR0036	Parafuso autoatarraxante cabeça panela phillips 4,8x32mm - Inox	12	PÇ
B		OLG-PAR0010	Parafuso autoatarraxante cabeça panela phillips 3,9 x 6,5 mm - Inox	((L*2+H*2)/250)	PÇ
C		OLG-NYL0031	Batedeira universal	04	PÇ
D		OLG-VED001	Junta de vedação marco superior/inferior	02	PÇ
E		OLG-VED0153	Junta de vedação marco inferior	02	PÇ
F		OLG-NYL0042	Vedação inferior / superior - 03 escovas	04	PÇ
G		OLG-NYL0048	Tampa da pingadeira e barreira de condensação	02	PAR
H		OLG-NYL0034	Dreno com portinhola	02	CJ
I		OLG-FEC0114	Contra fecho	02	PÇ
J		CONSULTAR TABELA	Fecho concha	02	PÇ
K		OLG-FEC0138	Lingueta	02	PÇ
L		OLG-CON0001-PTO	Conexão de alinhamento da folha	24	PÇ
M		OLG-CON0007-NAT	Macho que conexão 45° - 26,6x10	12	PÇ
N		OLG-NYL0003	Kit guia deslizante	04	CJ
O		CONSULTAR TABELA	Roldana	06	PÇ
P		OLG-VED0010-PTO	Guarnição perimetral e mão de amigo	((L*4)+(H*12))	MM
Q		Vide tabela	Guarnição do vidro	((L*4)+(H*12))	MM
R		OLG-VED0016-PTO	Calço de apoio do vidro	06	PÇ
S		OLG-PAR0021	Parafuso autoatarraxante cabeça panela phillips 4,2x 13 mm - Inox	(H*4)/250	PÇ

FECHOS

CÓDIGO OLGA	TIPO	COR
OLG-FEC0001-BCO	SEM CHAVE	BRANCO
OLG-FEC0001-PRA	SEM CHAVE	PRATA
OLG-FEC0001-PTO	SEM CHAVE	PRETO
OLG-FEC0002-BCO	COM CHAVE	BRANCO
OLG-FEC0002-PRA	COM CHAVE	PRATA
OLG-FEC0002-PTO	COM CHAVE	PRETO
OLG-FEC0003-BCO	CEGA	BRANCO
OLG-FEC0003-PRA	CEGA	PRATA
OLG-FEC0003-PTO	CEGA	PRETO
OLG-FEC0004-BCO	SEM CHAVE	BRANCO
OLG-FEC0004-PRA	SEM CHAVE	PRATA
OLG-FEC0004-PTO	SEM CHAVE	PRETO
OLG-FEC0005-BCO	COM CHAVE	BRANCO
OLG-FEC0005-PRA	COM CHAVE	PRATA
OLG-FEC0005-PTO	COM CHAVE	PRETO
OLG-FEC0006-BCO	CEGA	BRANCO
OLG-FEC0006-PRA	CEGA	PRATA
OLG-FEC0006-PTO	CEGA	PRETO

CORRER 02 FOLHAS SEMI-MINIMALISTA

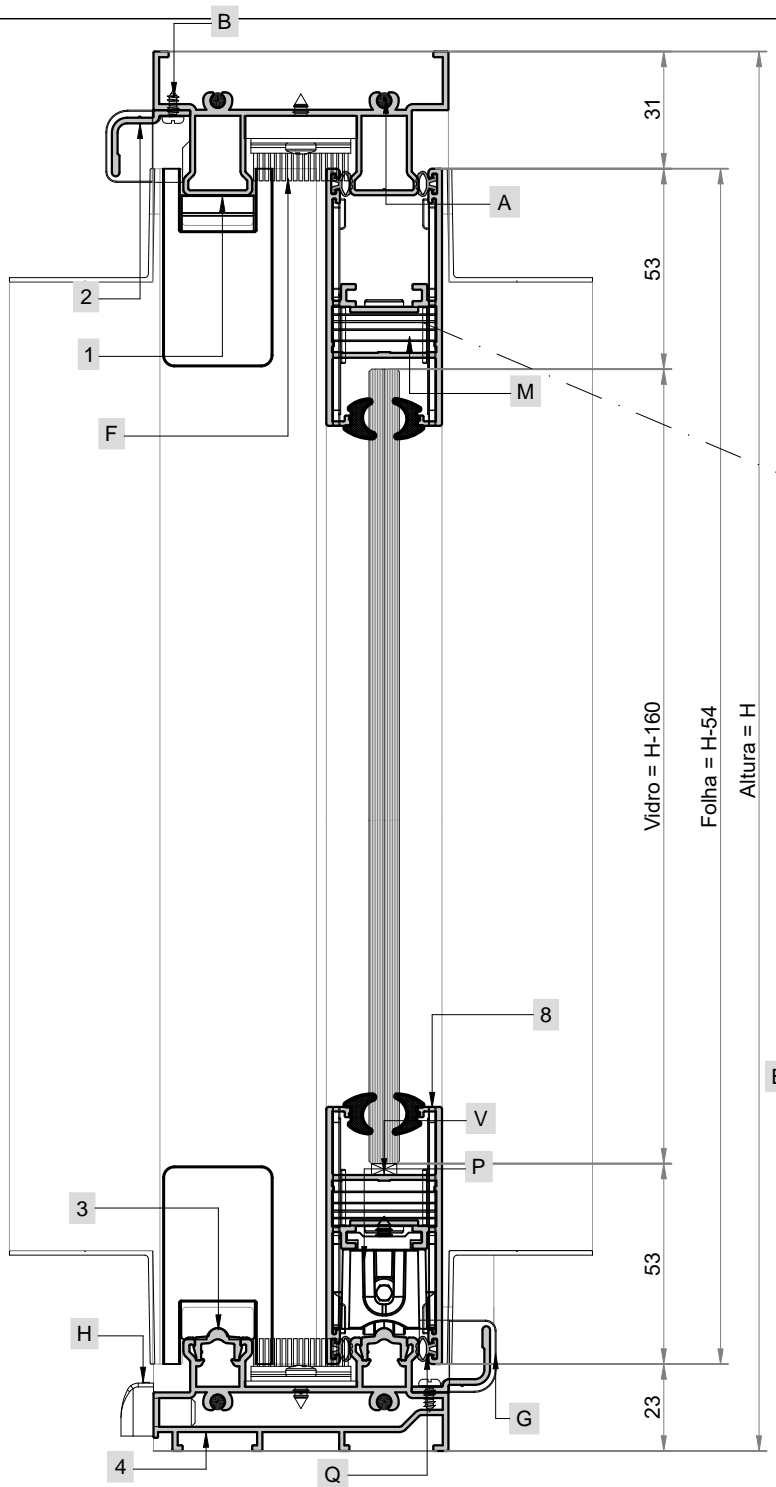
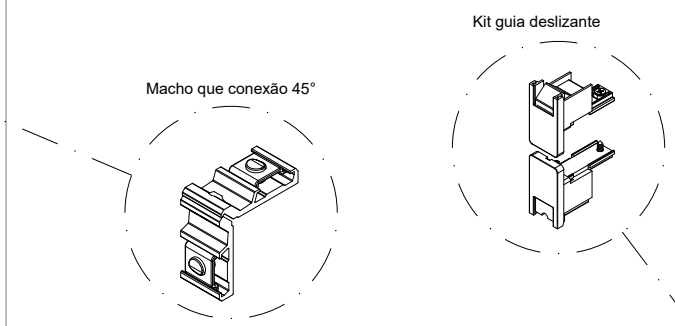
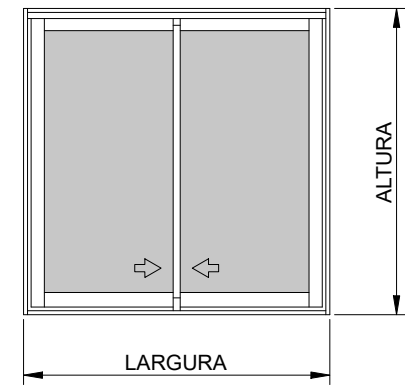

Vidro = H-160
Folha = H-54
Altura = H

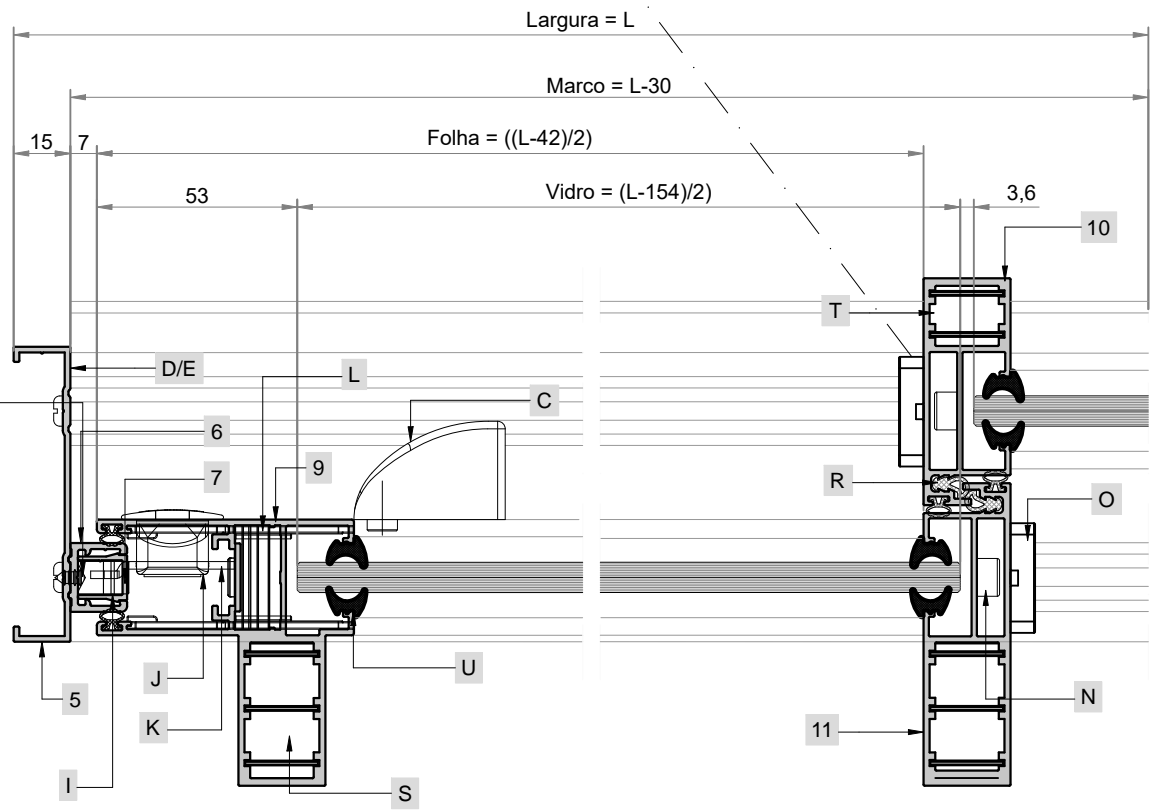

Largura = L
Marco = L-30
Folha = ((L-42)/2)
Vidro = (L-154)/2

Todas as informações são de propriedades da Olgacolor e estão sujeitas a alterações sem aviso prévio.

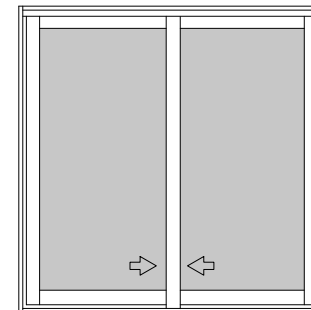
CORRER 02 FOLHAS
SEMI-MINIMALISTA

LISTA DE CORTE

POS.	ÍCONE	CÓDIGO	DESCRIÇÃO	ANGULO	DIREÇÃO	QUANT.	FÓRMULA
1		GSK001	Marco superior	90/90°	L	01	L-30
2		GSK006	Pingadeira e barreira de condensação	90/90°	L	02	L-36
3		GSK007	Trilho	90/90°	L	02	L-34
4		GSK002	Marco inferior	90/90°	L	01	L-30
5		GSK003	Marco lateral	90/90°	H	02	H
6		GSK004	Mata junta lateral	90/90°	H	02	H-68
7		GSK005	Tampa de acabamento	90/90°	H	02	H-68
8		GSK024	Travessa superior e inferior	45/90°	L	04	((L-42)/2)
9		GSK023	Montante lateral	45/45°	H	02	H-54
10		GSK027	Mão de amigo interno	90/90°	H	01	H-54
11		GSK026	Mão de amigo externo	90/90°	H	01	H-54

ROLDANAS

CÓDIGO OLGA	CARGA	COR
OLG-ROL0001-001	40KG	S/A
OLG-ROL0002-001	80KG	S/A
OLG-ROL0003-001	200KG	S/A

LISTA DE COMPONENTES

POS.	ÍCONE	CÓDIGO OLGA	DESCRIÇÃO	FÓRMULA	UN.
A		OLG-PAR0036	Parafuso autoatarraxante cabeça panela phillips 4,8x32mm - Inox	08	PÇ
B		OLG-PAR0010	Parafuso autoatarraxante cabeça panela phillips 3,9 x 6,5 mm - Inox	((L*2+H*2)/250)	PÇ
C		OLG-NYL0031	Batedeira universal	04	PÇ
D		OLG-VED001	Junta de vedação marco superior	02	PÇ
E		OLG-VED001	Junta de vedação marco inferior	02	PÇ
F		OLG-NYL0041	Vedação inferior / superior - 02 escovas	02	PÇ
G		OLG-NYL0048	Tampa da pingadeira e barreira de condensação	02	PAR
H		OLG-NYL0034	Dreno com portinhola	01	CJ
I		OLG-FEC0114	Contra fecho	02	PÇ
J		CONSULTAR TABELA	Fecho concha	02	PÇ
K		OLG-FEC0138	Lingueta	02	PÇ
L		OLG-CON0001-PTO	Conexão de alinhamento da folha	08	PÇ
M		OLG-CON0007-NAT	Macho que conexão 45° - 26,6x10	04	PÇ
N		OLG-CON0004-NAT	Macho que conexão 90° - 26,6x10	04	PÇ
O		OLG-NYL0003	Kit guia deslizante	02	CJ
P		CONSULTAR TABELA	Roldana	04	PÇ
Q		OLG-VED0010-PTO	Guarnição perimetral e mão de amigo	((L*4)+(H*6))	MM
R		OLG-VED0011-PTO	Guarnição mão de amigo	H*2	MM
S		OLG-NYL0051	Tampa montante GSK026/ GSK023	06	PÇ
T		OLG-NYL0050	Tampa montante GSK027	02	PÇ
U		Vide tabela	Guarnição do vidro	((L*4)+(H*8))	MM
V		OLG-VED0016-PTO	Calço de apoio do vidro	04	PÇ

FECHOS

CÓDIGO OLGA	TIPO	COR
OLG-FEC0001-BCO	SEM CHAVE	BRANCO
OLG-FEC0001-PRA	SEM CHAVE	PRATA
OLG-FEC0001-PTO	SEM CHAVE	PRETO
OLG-FEC0002-BCO	COM CHAVE	BRANCO
OLG-FEC0002-PRA	COM CHAVE	PRATA
OLG-FEC0002-PTO	COM CHAVE	PRETO
OLG-FEC0003-BCO	CEGA	BRANCO
OLG-FEC0003-PRA	CEGA	PRATA
OLG-FEC0003-PTO	CEGA	PRETO
OLG-FEC0004-BCO	SEM CHAVE	BRANCO
OLG-FEC0004-PRA	SEM CHAVE	PRATA
OLG-FEC0004-PTO	SEM CHAVE	PRETO
OLG-FEC0005-BCO	COM CHAVE	BRANCO
OLG-FEC0005-PRA	COM CHAVE	PRATA
OLG-FEC0005-PTO	COM CHAVE	PRETO
OLG-FEC0006-BCO	CEGA	BRANCO
OLG-FEC0006-PRA	CEGA	PRATA
OLG-FEC0006-PTO	CEGA	PRETO

Todas as informações são de propriedades da Olgacolor e estão sujeitas a alterações sem aviso prévio.

CORRER 04 FOLHAS SEMI-MINIMALISTA

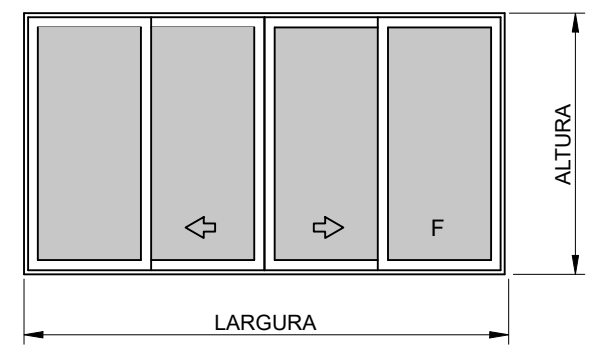

ELEVAÇÃO VISTA EXTERNA
SEM ESCALA

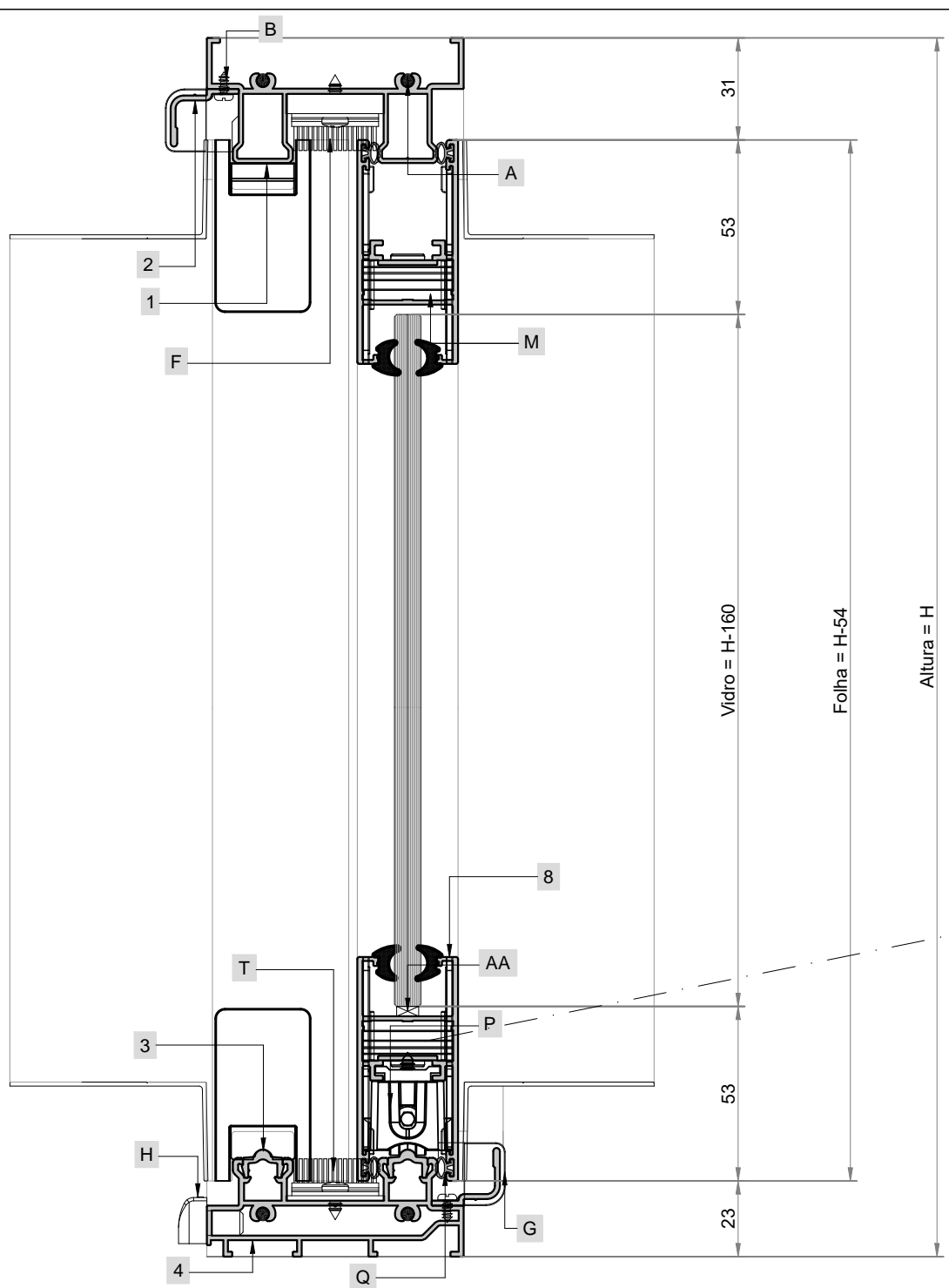
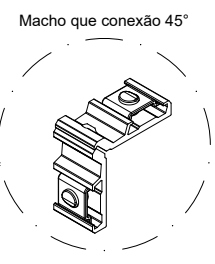

Todas as informações são de propriedades da Olgacolor e estão sujeitas a alterações sem aviso prévio.

CORRER 04 FOLHAS SEMI-MINIMALISTA

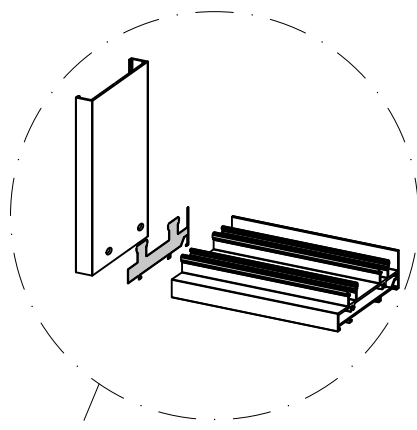

Junta de vedação dos trilhos

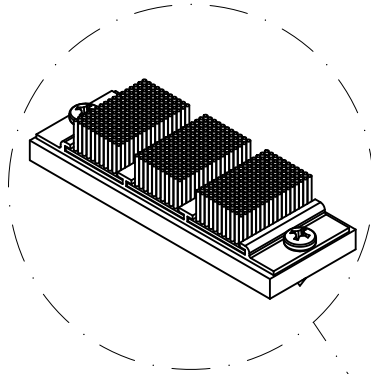

Vedação inferior / superior - 03 escovas

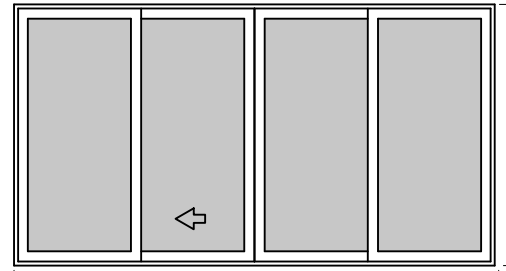

LARGURA

ALTURA

ELEVAÇÃO VISTA EXTERNA
SEM ESCALA

Largura = L

Marco = L-30

Folha = $((L-46)/4)$

Vidro = $((L-271)/4)$

113

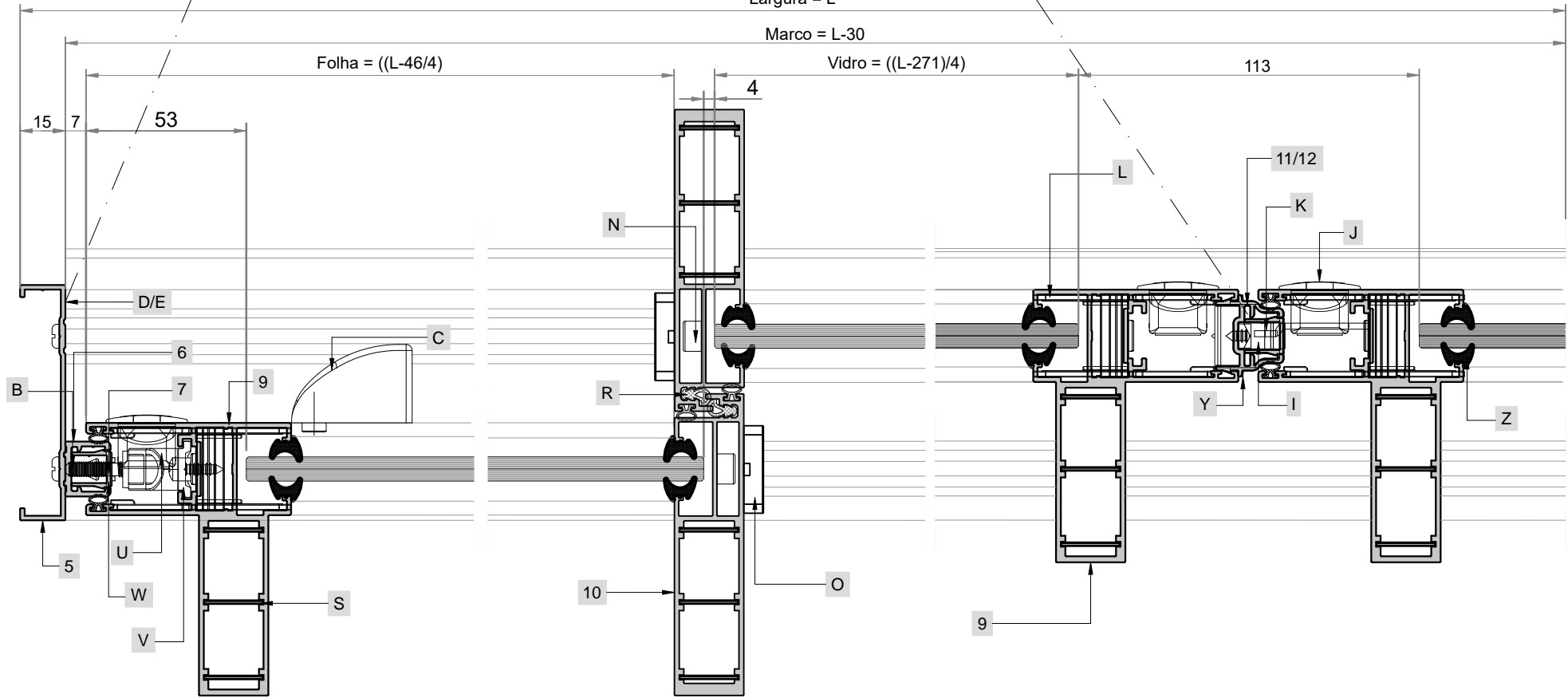

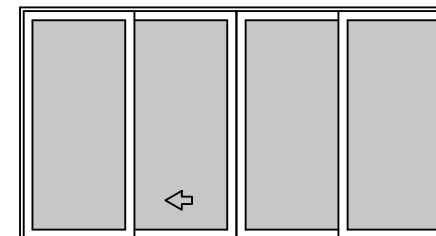
CORRER 04 FOLHAS
SEMI-MINIMALISTA

LISTA DE CORTE

POS.	ÍCONE	CÓDIGO	DESCRIÇÃO	ÂNGULO	DIREÇÃO	QUANT.	FÓRMULA
1		GSK001	Marco superior	90/90°	L	01	L-30
2		GSK006	Pingadeira e barreira de condensação	90/90°	L	02	L-34
3		GSK007	Trilho	90/90°	L	02	L-30
4		GSK002	Marco inferior	90/90°	L	01	L-30
5		GSK003	Marco lateral	90/90°	H	02	H
6		GSK004	Mata junta lateral	90/90°	H	02	H-68
7		GSK005	Tampa de acabamento	90/90°	H	02	H-68
8		GSK024	Travessa superior e inferior	45/90°	L	08	((L-46/4)
9		GSK022	Montante lateral e central	45/45°	H	04	H-54
10		GSK025	Mão de amigo	90/90°	H	04	H-54
11		GSK012	Mata junta central	90/90°	H	01	H-54
12		GSK005	Tampa de acabamento	90/90°	H	01	H-54

ROLDANAS

CÓDIGO OLGA	CARGA	COR
OLG-ROL0001-001	40KG	S/A
OLG-ROL0002-001	80KG	S/A
OLG-ROL0003-001	200KG	S/A

LISTA DE COMPONENTES

POS.	ÍCONE	CÓDIGO OLGA	DESCRIÇÃO	FÓRMULA	UN.
A		OLG-PAR0036	Parafuso autoatarraxante cabeça panela phillips 4,8x32mm - Inox	08	PÇ
B		OLG-PAR0010	Parafuso autoatarraxante cabeça panela phillips 3,9 x 6,5 mm - Inox	((L*2+H*2)/250)	PÇ
C		OLG-NYL0031	Batedeira universal	04	PÇ
D		OLG-VED001	Junta de vedação marco superior	01	PR
E		OLG-VED001	Junta de vedação marco inferior	01	PR
F		OLG-NYL0041	Vedação inferior / superior - 02 escovas	04	PÇ
G		OLG-NYL0048	Tampa da pingadeira e barreira de condensação	02	PAR
H		OLG-NYL0034	Dreno com portinhola	02	CJ
I		OLG-FEC0114	Contra fecho	01	PÇ
J		CONSULTAR TABELA	Fecho concha	04	PÇ
K		OLG-FEC0138	Lingueta	01	PÇ
L		OLG-CON0001-PTO	Conexão de alinhamento da folha	16	PÇ
M		OLG-CON0007-NAT	Macho que conexão 45° - 26,6x10	08	PÇ
N		OLG-CON0004-NAT	Macho que conexão 90° - 26,6x10	08	PÇ
O		OLG-NYL0003	Kit guia deslizante	04	CJ
P		CONSULTAR TABELA	Roldana	04	PÇ
Q		OLG-VED0010-PTO	Guarnição perimetral e mão de amigo	((L*4)+(H*10))	MM
R		OLG-VED0011-PTO	Guarnição mão de amigo	H*4	MM
S		OLG-NYL0052	Tampa montante GSK022/ GSK025	16	PÇ
T		OLG-NYL0042	Vedação inferior / superior - 03 escovas	02	PÇ
U		OLG-FEC0125-PTO	Bico fecho bulón regulável	04	PÇ
V		OLG-FEC0127-PTO	Fixador trava da folha fixa	08	PÇ
W		OLG-FEC0116-INX	Contra fecho inox	04	PÇ
X		OLG-NYL0021-PTO	Calço da folha fixa	04	PÇ
Y		OLG-NYL0020	Kit vedação central	01	CJ
Z		Vide tabela	Guarnição do vidro	((L*4)+(H*16))	MM
AA		OLG-VED0016-PTO	Calço de apoio do vidro	08	PÇ

FECHOS

CÓDIGO OLGA	TIPO	COR
OLG-FEC0001-BCO	SEM CHAVE	BRANCO
OLG-FEC0001-PRA	SEM CHAVE	PRATA
OLG-FEC0001-PTO	SEM CHAVE	PRETO
OLG-FEC0002-BCO	COM CHAVE	BRANCO
OLG-FEC0002-PRA	COM CHAVE	PRATA
OLG-FEC0002-PTO	COM CHAVE	PRETO
OLG-FEC0003-BCO	CEGA	BRANCO
OLG-FEC0003-PRA	CEGA	PRATA
OLG-FEC0003-PTO	CEGA	PRETO
OLG-FEC0004-BCO	SEM CHAVE	BRANCO
OLG-FEC0004-PRA	SEM CHAVE	PRATA
OLG-FEC0004-PTO	SEM CHAVE	PRETO
OLG-FEC0005-BCO	COM CHAVE	BRANCO
OLG-FEC0005-PRA	COM CHAVE	PRATA
OLG-FEC0005-PTO	COM CHAVE	PRETO
OLG-FEC0006-BCO	CEGA	BRANCO
OLG-FEC0006-PRA	CEGA	PRATA
OLG-FEC0006-PTO	CEGA	PRETO

Todas as informações são de propriedades da Olgacolor e estão sujeitas a alterações sem aviso prévio.

JANELA DE CORRER 02 FOLHAS COM VIDRO COLADO

VIDROS
Sistema atende vidros de 06mm, 08mm e 10mm de espessura

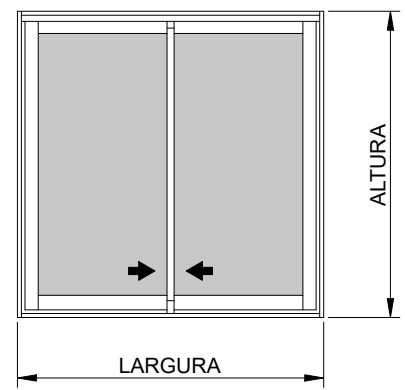

ELEVAÇÃO VISTA EXTERNA
SEM ESCALA

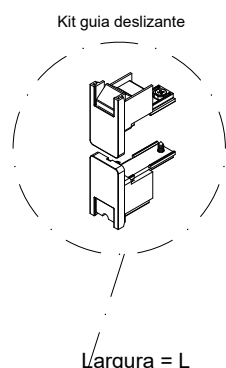
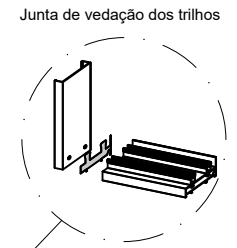
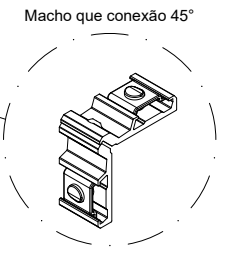

Largura = L

Marco = L-30

Folha = $((L+9)/2)$

Vidro A

Vidro B

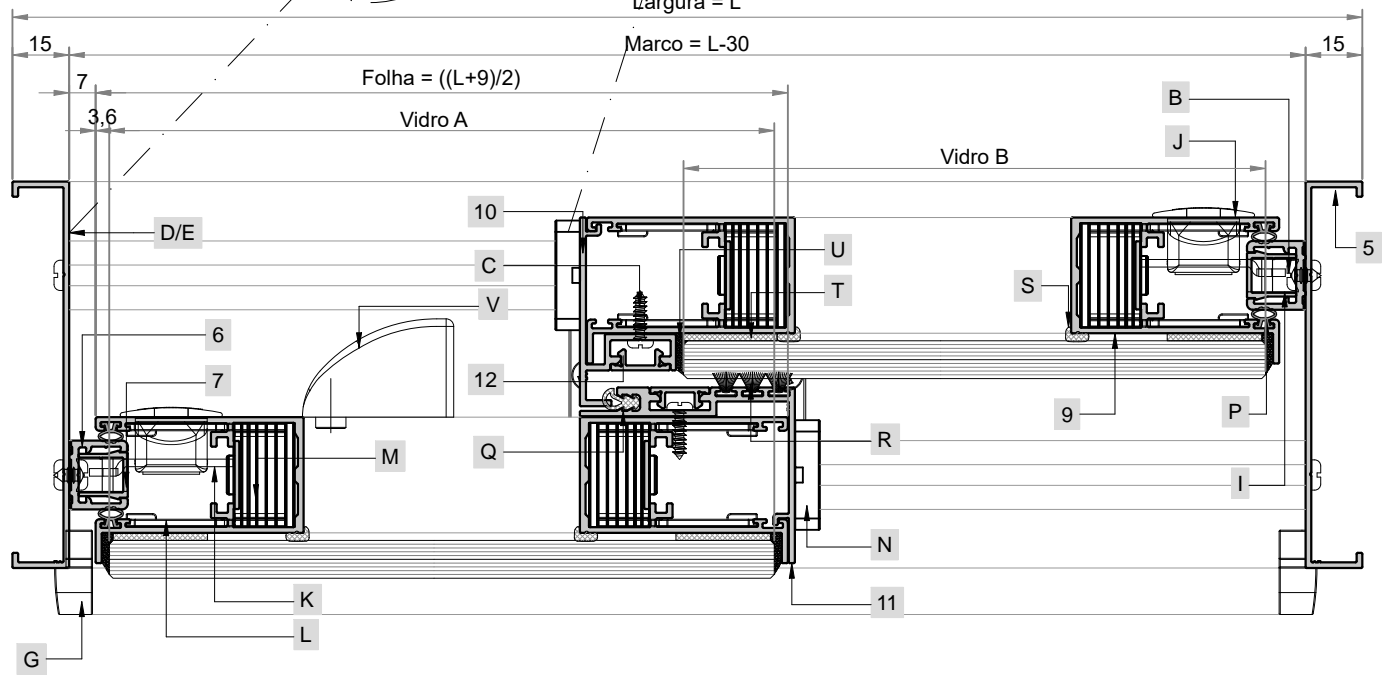
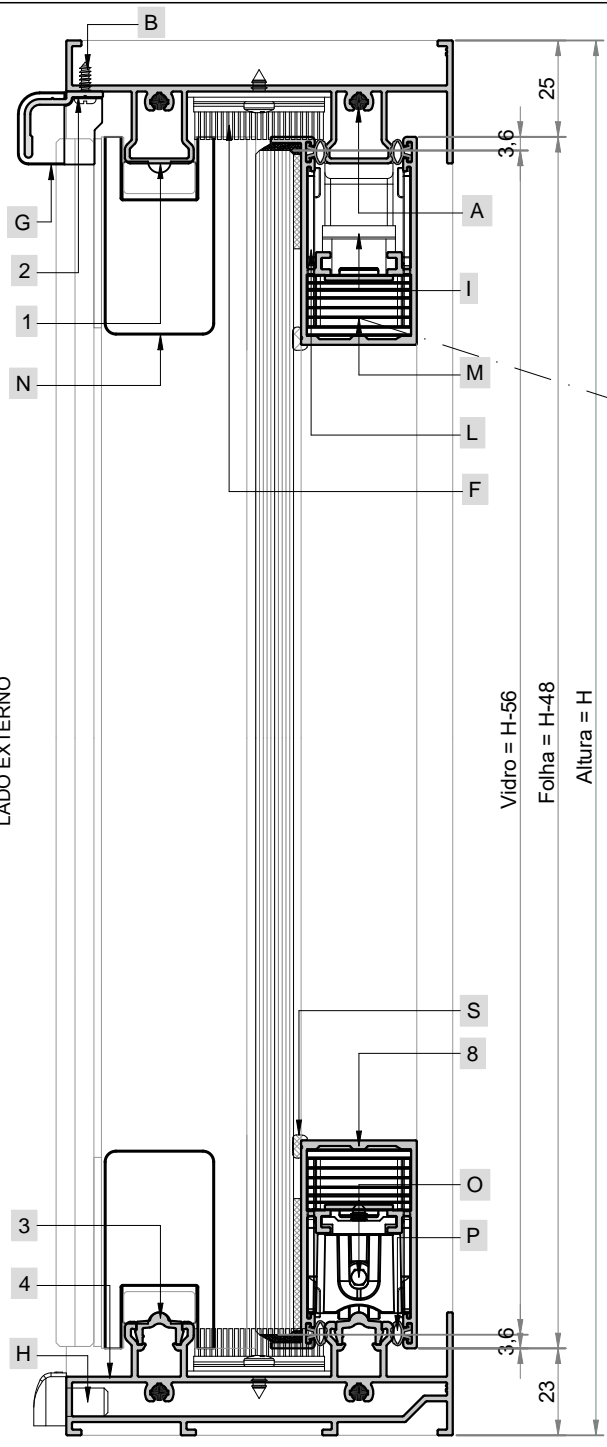

LADO EXTERNO

ESCALA: 1:2

Todas as informações são de propriedades da Olgacolor e estão sujeitas a alterações sem aviso prévio.

LISTA DE CORTE

POS.	ÍCONE	CÓDIGO	DESCRIÇÃO	ÂNGULO	DIREÇÃO	QUANT.	FÓRMULA
1		GSK040	Marco superior	90/90°	L	01	L-30
2		GSK006	Pingadeira	90/90°	L	01	L-36
3		GSK007	Trilho	90/90°	L	02	L-34
4		GSK041	Marco inferior	90/90°	L	01	L-30
5		GSK042	Marco lateral	90/90°	H	02	H
6		GSK004	Mata junta lateral	90/90°	H	02	H-62
7		GSK005	Tampa de acabamento	90/90°	H	02	H-62
8		GSK043	Travessa superior e inferior	45/45°	L	04	((L+9)/2)
9		GSK043	Montate lateral e mão de amigo	45/45°	H	04	H-48
10		GSK044	Mão de amigo	90/90°	H	01	H-48
11		GSK045	Mão de amigo	90/90°	H	01	H-48
12		GSK410	Tampa de acabamento	90/90°	H	02	H-48

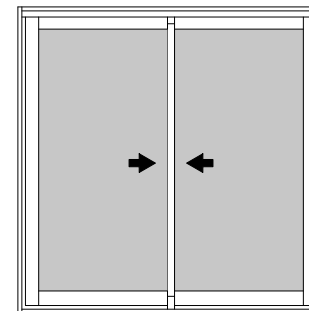
JANELA DE CORRER 02 FOLHAS
COM VIDRO COLADO

LISTA DE COMPONENTES

POS.	ÍCONE	CÓDIGO OLGA	DESCRIÇÃO	FÓRMULA	UN.
A		OLG-PAR0036	Parafuso autoatarraxante cabeça panela phillips 4,8x32mm - Inox	08	PÇ
B		OLG-PAR0020	Parafuso autoatarraxante cabeça panela phillips 4,2 x 9,5 mm - Inox	((L+H*2)/250)	PÇ
C		OLG-PAR0021	Parafuso autoatarraxante cabeça panela phillips 4,2 x 13 mm - Inox	((H*2)/250)	PÇ
D		OLG-VED0154	Junta de vedação marco superior	02	PÇ
E		OLG-VED0153	Junta de vedação marco inferior	02	PÇ
F		OLG-NYL0087	Vedação inferior / superior - 02 escovas	02	PÇ
G		OLG-NYL0048	Tampa da pingadeira	01	PAR
H		OLG-NYL0034	Dreno com portinhola	01	CJ
I		OLG-FEC0114	Contra fecho	02	PÇ
J		CONSULTAR TABELA	Fecho concha	02	PÇ
K		OLG-FEC0138	Lingueta	02	PÇ
L		OLG-CON0001-PTO	Conexão de alinhamento da folha	16	PÇ
M		OLG-CON0024-NAT	Macho de conexão 45° - 26,6x14,5	08	PÇ
N		OLG-NYL0003	Kit guia deslizante	02	CJ
O		CONSULTAR TABELA	Roldana	04	PÇ
P		OLG-VED0010-PTO	Guarnição perimetral da folha	((L*4)+(H*4))	MM
Q		OLG-VED0011-PTO	Guarnição mão de amigo	H	MM
R		CONSULTAR TABELA	Escova quadrifin	H*3	MM
S		OLG-VED144-PTO	Guarnição interna da folha	((L*2)+(H*4))	MM
T		OLG-VED0143	Fita dupla face	((L*2)+(H*4))	MM
U		OLG-VED0145	Silicone estrutural	Variável	TB
V		OLG-NYL0031	Batedeira universal	02	PÇ

ROLDANAS

CÓDIGO OLGA	CARGA	COR
OLG-ROL0001-001	40KG	S/A
OLG-ROL0002-001	80KG	S/A
OLG-ROL0003-001	200KG	S/A

VIDROS

VIDRO	LARGURA	ALTURA	QUANT.
A	((L/2)-3)	H-56	01
B	((L/2)-25)	H-56	01

FECHOS

CÓDIGO OLGA	TIPO	COR
OLG-FEC0001-BCO	SEM CHAVE	BRANCO
OLG-FEC0001-PRA	SEM CHAVE	PRATA
OLG-FEC0001-PTO	SEM CHAVE	PRETO
OLG-FEC0002-BCO	COM CHAVE	BRANCO
OLG-FEC0002-PRA	COM CHAVE	PRATA
OLG-FEC0002-PTO	COM CHAVE	PRETO

ESCOVAS

CÓDIGO OLGA	DIMENSÃO	VIDRO
OLG-VED0132-PTO	5X10	06MM
OLG-VED0131-PTO	5X8	08MM
OLG-VED0129-PTO	5X6	10MM

Todas as informações são de propriedades da Olgacolor e estão sujeitas a alterações sem aviso prévio.

JANELA DE CORRER 04 FOLHAS COM VIDRO COLADO

VIDROS
Sistema atende vidros de
06mm, 08mm e 10mm de
espessura

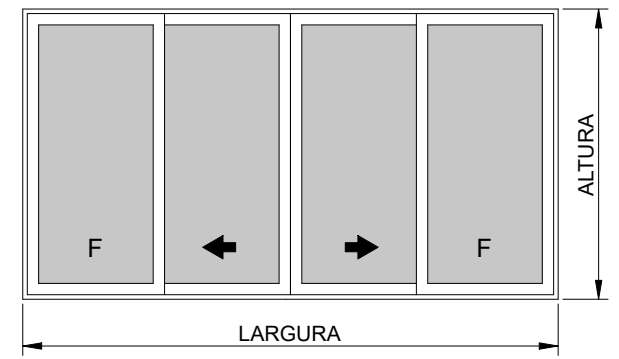

ELEVAÇÃO VISTA EXTERNA
SEM ESCALA

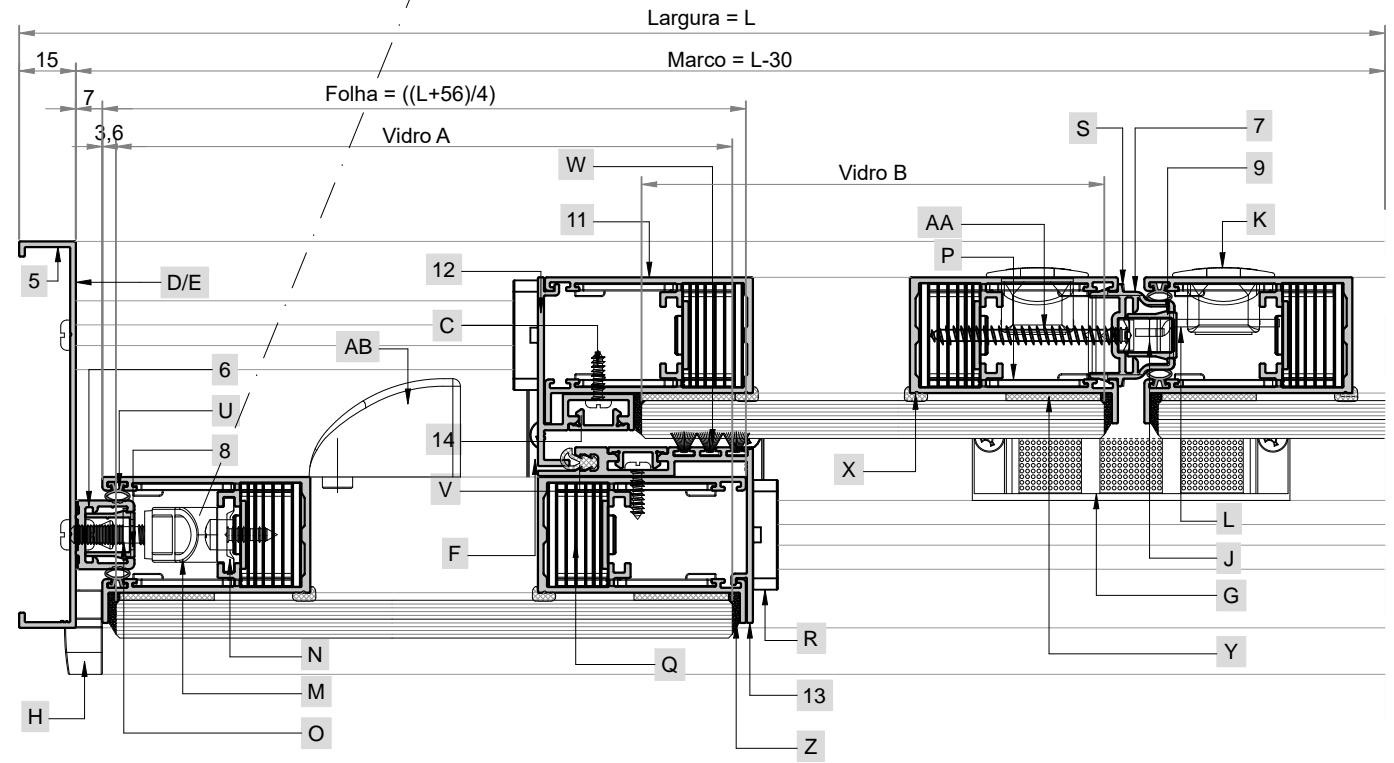
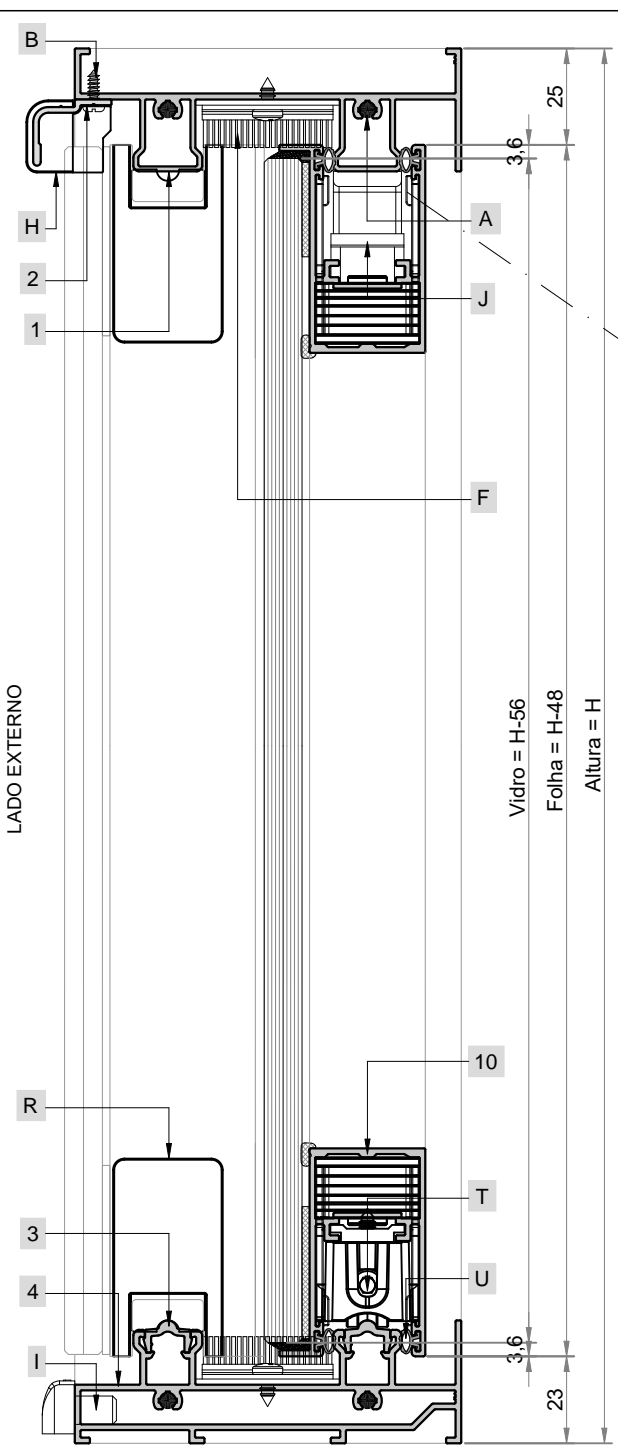
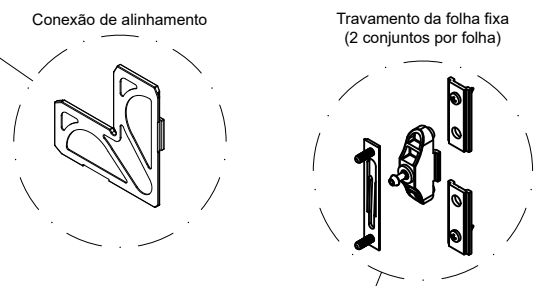

LADO EXTERNO

ESCALA: 1:2

Todas as informações são de propriedades da Olgacolor e estão sujeitas a alterações sem aviso prévio.

JANELA DE CORRER 04 FOLHAS COM VIDRO COLADO

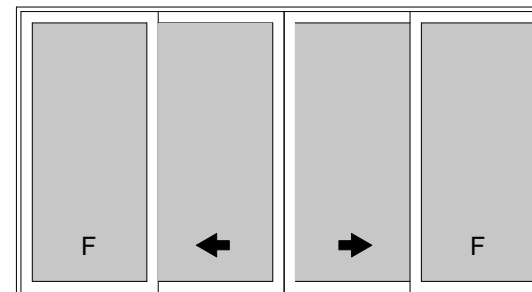

LISTA DE CORTE

POS.	ÍCONE	CÓDIGO	DESCRIÇÃO	ANGULO	DIREÇÃO	QUANT.	FÓRMULA
1		GSK040	Marco superior	90/90°	L	01	L-30
2		GSK006	Pingadeira	90/90°	L	01	L-36
3		GSK007	Trilho	90/90°	L	02	L-34
4		GSK041	Marco inferior	90/90°	L	01	L-30
5		GSK042	Marco lateral	90/90°	H	02	H
6		GSK004	Mata junta lateral	90/90°	H	02	H-62
7		GSK012	Mata junta central	90/90°	H	01	H-48
8		GSK005	Tampa de acabamento lateral	90/90°	H	02	H-62
9		GSK005	Tampa de acabamento central	90/90°	H	01	H-48
10		GSK043	Travessa superior e inferior	45/45°	L	08	((L+56)/4)
11		GSK043	Montate lateral e mão de amigo	45/45°	H	08	H-48
12		GSK044	Mão de amigo	90/90°	H	02	H-48
13		GSK045	Mão de amigo	90/90°	H	02	H-48
14		GSK410	Tampa de acabamento	90/90°	H	04	H-48

LISTA DE COMPONENTES

POS.	ÍCONE	CÓDIGO OLGA	DESCRIÇÃO	FÓRMULA	UN.
A		OLG-PAR0036	Parafuso autoatarraxante cabeça panela phillips 4,8x32 mm Inox	08	PÇ
B		OLG-PAR0020	Parafuso autoatarraxante cabeça panela phillips 4,2 x 9,5 mm Inox	((L+H*2)/250)	PÇ
C		OLG-PAR0021	Parafuso autoatarraxante cabeça panela phillips 4,2 x 13 mm Inox	((H*4)/250)	PÇ
D		OLG-VED0154	Junta de vedação superior	02	PÇ
E		OLG-VED0153	Junta de vedação inferior	02	PÇ
F		OLG-NYL0087	Vedação inferior / superior - 02 escovas	04	PÇ
G		OLG-NYL0088	Vedação inferior / superior - 03 escovas	02	PÇ
H		OLG-NYL0048	Tampa da pingadeira	01	PAR
I		OLG-NYL0034	Dreno com portinhola	02	CJ
J		OLG-FEC0114	Contra fecho	01	PÇ
K		CONSULTAR TABELA	Fecho concha	02	PÇ
L		OLG-FEC0138	Lingueta	01	PÇ
M		OLG-FEC0125-PTO	Bico fecho bulón regulável	04	PÇ
N		OLG-FEC0127-PTO	Fixador trava da folha fixa	08	PÇ
O		OLG-FEC0116-INX	Contra fecho inox	04	PÇ
P		OLG-CON0001-PTO	Conexão de alinhamento da folha	32	PÇ
Q		OLG-CON0024-NAT	Macho de conexão 45° - 26,6x14,5	16	PÇ
R		OLG-NYL0003	Kit guia deslizante	04	CJ
S		OLG-NYL0020	Kit vedação central	01	CJ
T		CONSULTAR TABELA	Roldana	04	PÇ
U		OLG-VED0010-PTO	Guarnição perimetral da folha	((L*4)+(H*6))	MM
V		OLG-VED0011-PTO	Guarnição mão de amigo	H*2	MM
W		CONSULTAR TABELA	Escova quadrifin	H*6	MM
X		OLG-VED144-PTO	Guarnição interna da folha	((L*2)+(H*8))	MM
Y		OLG-VED0143	Fita dupla face	((L*2)+(H*8))	MM
Z		OLG-VED0145	Silicone estrutural	Variável	TB
AA		OLG-PAR0029	Parafuso autoatarraxante cabeça panela phillips 4,2 x 50 mm Inox	(H/250)	PÇ
AB		OLG-NYL0031	Batedeira universal	04	PÇ
AC		OLG-NYL0021-PTO	Calço da folha fixa	04	PÇ

ROLDANAS

CÓDIGO OLGA	CARGA	COR
OLG-ROL0001-001	40KG	S/A
OLG-ROL0002-001	80KG	S/A
OLG-ROL0003-001	200KG	S/A

VIDROS

VIDRO	LARGURA	ALTURA	QUANT.
A	((L/4)+7)	H-56	02
B	((L/4)-15)	H-56	02

FECHOS

CÓDIGO OLGA	TIPO	COR
OLG-FEC0001-BCO	SEM CHAVE	BRANCO
OLG-FEC0001-PRA	SEM CHAVE	PRATA
OLG-FEC0001-PTO	SEM CHAVE	PRETO
OLG-FEC0002-BCO	COM CHAVE	BRANCO
OLG-FEC0002-PRA	COM CHAVE	PRATA
OLG-FEC0002-PTO	COM CHAVE	PRETO
OLG-FEC0003-BCO	CEGA	BRANCO
OLG-FEC0003-PRA	CEGA	PRATA
OLG-FEC0003-PTO	CEGA	PRETO

ESCOVAS

CÓDIGO OLGA	DIMENSÃO	VIDRO
OLG-VED0132-PTO	5X10	06MM
OLG-VED0131-PTO	5X8	08MM
OLG-VED0129-PTO	5X6	10MM

JANELA DE CORRER 03 FOLHAS COM VIDRO COLADO

VIDROS
Sistema atende vidros de 06mm, 08mm e 10mm de espessura

Aplicação da junta de vedação

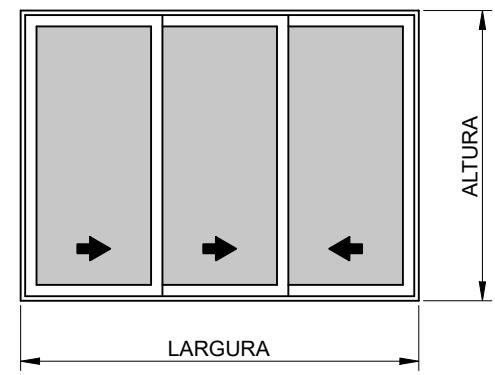
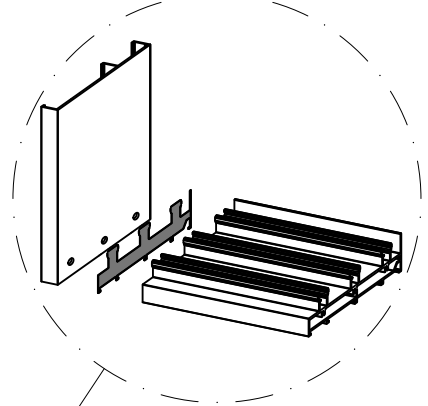

ELEVAÇÃO VISTA EXTERNA
SEM ESCALA

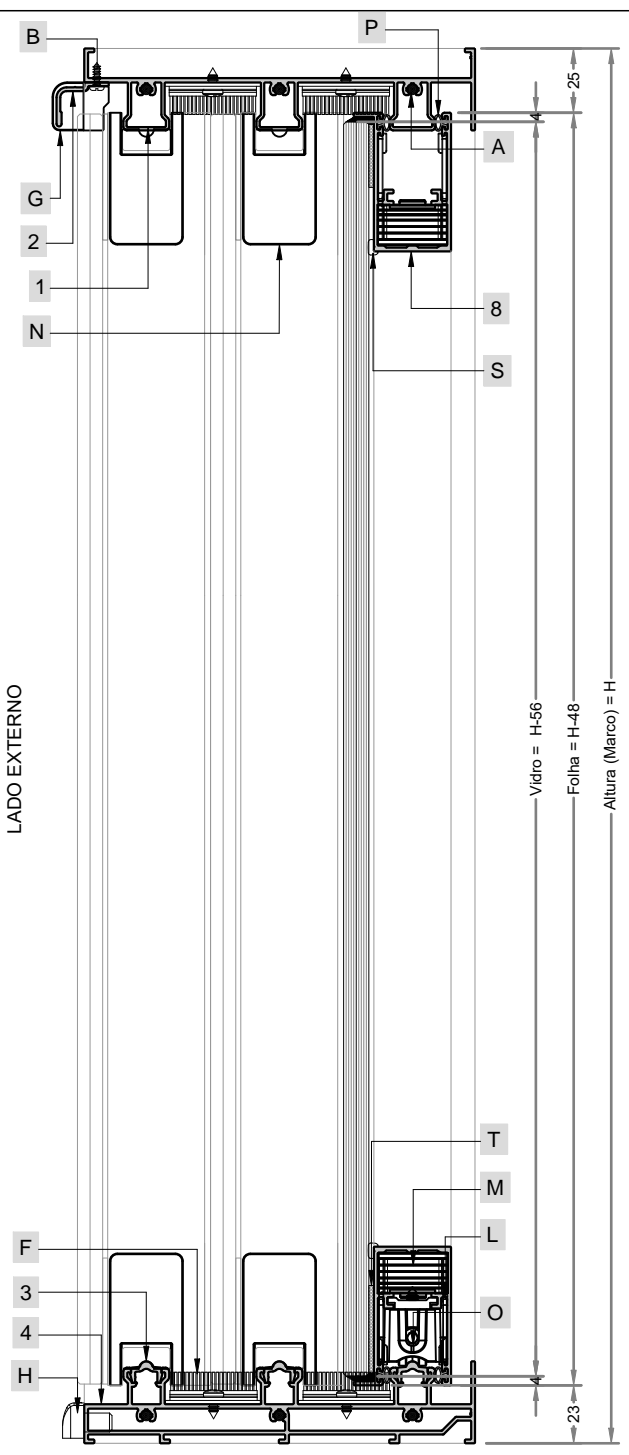

— Vidro = H-56
— Folha = H-48
— Altura (Marco) = H

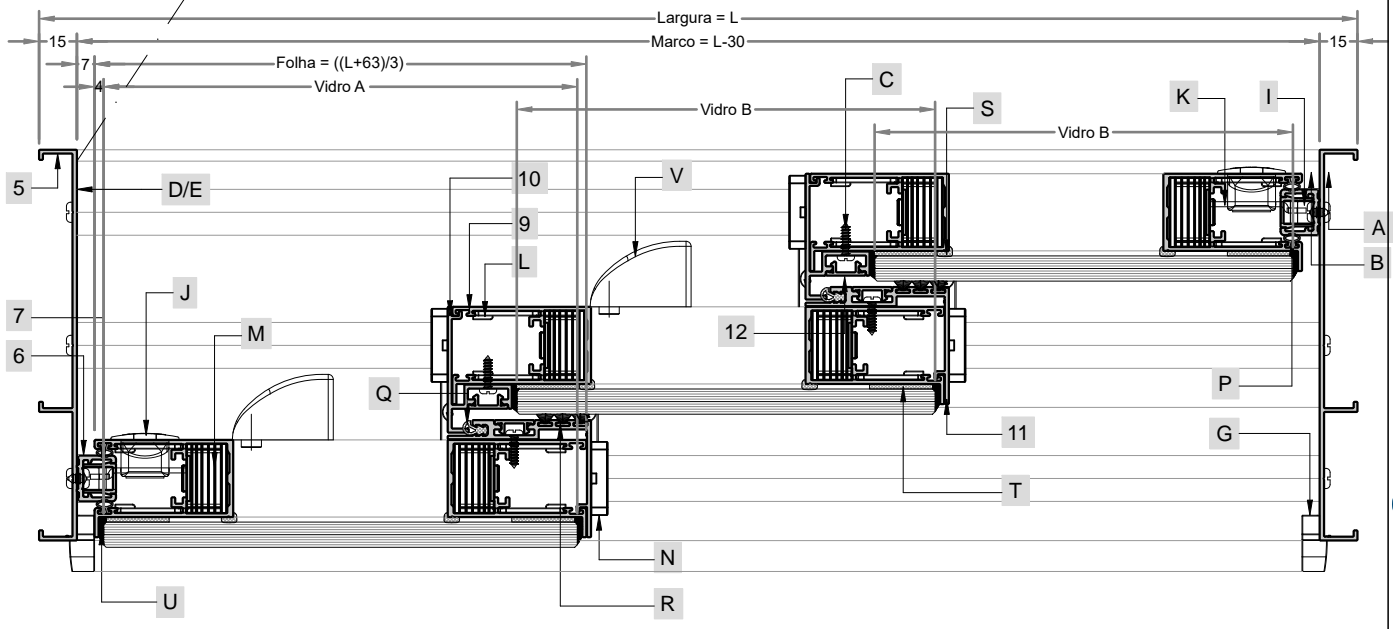

LADO EXTERNO

ESCALA: 1:3

Todas as informações são de propriedades da Olgacolor e estão sujeitas a alterações sem aviso prévio.

JANELA DE CORRER 03 FOLHAS COM VIDRO COLADO

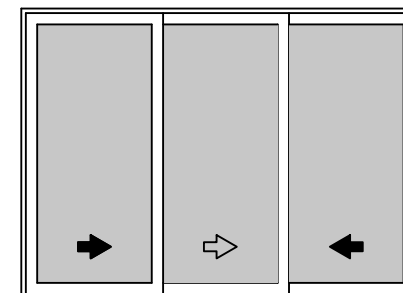

LISTA DE CORTE

POS.	ÍCONE	CÓDIGO	DESCRIÇÃO	ANGULO	DIREÇÃO	QUANT.	FÓRMULA
1		GSK050	Marco superior	90/90°	L	01	L-30
2		GSK006	Pingadeira	90/90°	L	01	L-36
3		GSK007	Trilho	90/90°	L	03	L-34
4		GSK051	Marco inferior	90/90°	L	01	L-30
5		GSK052	Marco lateral	90/90°	H	02	H
6		GSK004	Mata junta lateral	90/90°	H	02	H-62
7		GSK005	Tampa de acabamento	90/90°	H	02	H-62
8		GSK043	Travessa superior e inferior	45/45°	L	06	((L+63)/3)
9		GSK043	Montate lateral e mão de amigo	45/45°	H	06	H-48
10		GSK044	Mão de amigo	90/90°	H	02	H-48
11		GSK045	Mão de amigo	90/90°	H	02	H-48
12		GSK410	Tampa de acabamento	90/90°	H	04	H-48

LISTA DE COMPONENTES

POS.	ÍCONE	CÓDIGO OLG	DESCRIÇÃO	FÓRMULA	UN.
A		OLG-PAR0036	Parafuso autoatarraxante cabeça panela phillips 4,8x32mm - Inox	12	PÇ
B		OLG-PAR0020	Parafuso autoatarraxante cabeça panela phillips 4,2 x 9,5 mm - Inox	((L+H*2)/250)	PÇ
C		OLG-PAR0021	Parafuso autoatarraxante cabeça panela phillips 4,2 x 13 mm - Inox	((H*4)/250)	PÇ
D		OLG-VED0152	Junta de vedação marco superior	02	PÇ
E		OLG-VED0151	Junta de vedação marco inferior	02	PÇ
F		OLG-NYL0087	Vedação inferior / superior - 02 escovas	04	PÇ
G		OLG-NYL0048	Tampa da pingadeira	01	PAR
H		OLG-NYL0034	Dreno com portinhola	02	CJ
I		OLG-FEC0114	Contra fecho	02	PÇ
J		CONSULTAR TABELA	Fecho concha	02	PÇ
K		OLG-FEC0138	Lingueta	02	PÇ
L		OLG-CON0001-PTO	Conexão de alinhamento da folha	24	PÇ
M		OLG-CON0024-NAT	Macho de conexão 45° - 26.6x14,5	12	PÇ
N		OLG-NYL0003	Kit guia deslizante	04	CJ
O		CONSULTAR TABELA	Roldana	06	PÇ
P		OLG-VED0010-PTO	Guarnição perimetral da folha	((L*4)+(H*4))	MM
Q		OLG-VED0011-PTO	Guarnição mão de amigo	H*2	MM
R		CONSULTAR TABELA	Escova quadrifin	H*6	MM
S		OLG-VED144-PTO	Guarnição interna da folha	((L*2)+(H*6))	MM
T		OLG-VED0143	Fita dupla face	((L*2)+(H*6))	MM
U		OLG-VED0145	Silicone estrutural	Variável	TB
V		OLG-NYL0031	Batedeira universal	04	PÇ

ROLDANAS

CÓDIGO OLG	CARGA	COR
OLG-ROL0001-001	40KG	S/A
OLG-ROL0002-001	80KG	S/A
OLG-ROL0003-001	200KG	S/A

VIDROS

VIDRO	LARGURA	ALTURA	QUANT.
A	((L/3)+13)	H-56	01
B	((L/3)-9)	H-56	02

FECHOS

CÓDIGO OLG	TIPO	COR
OLG-FEC0001-BCO	SEM CHAVE	BRANCO
OLG-FEC0001-PRA	SEM CHAVE	PRATA
OLG-FEC0001-PTO	SEM CHAVE	PRETO
OLG-FEC0002-BCO	COM CHAVE	BRANCO
OLG-FEC0002-PRA	COM CHAVE	PRATA
OLG-FEC0002-PTO	COM CHAVE	PRETO

ESCOVAS

CÓDIGO OLG	DIMENSÃO	VIDRO
OLG-VED0132-PTO	5X10	06MM
OLG-VED0131-PTO	5X8	08MM
OLG-VED0129-PTO	5X6	10MM

JANELA CORRER 06 FOLHAS COM VIDRO COLADO

VIDROS
 Sistema atende vidros de 06mm, 08mm e 10mm de espessura

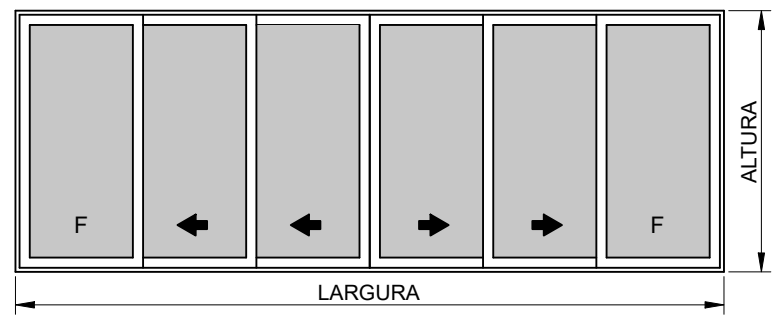

ELEVAÇÃO VISTA EXTERNA SEM ESCALA

Vedação inferior / superior - 03 escovas

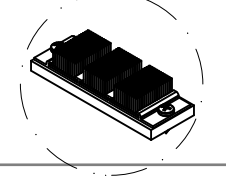
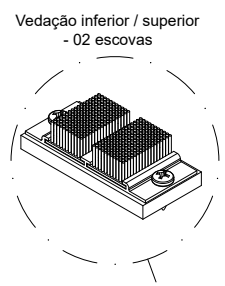

LADO EXTERNO

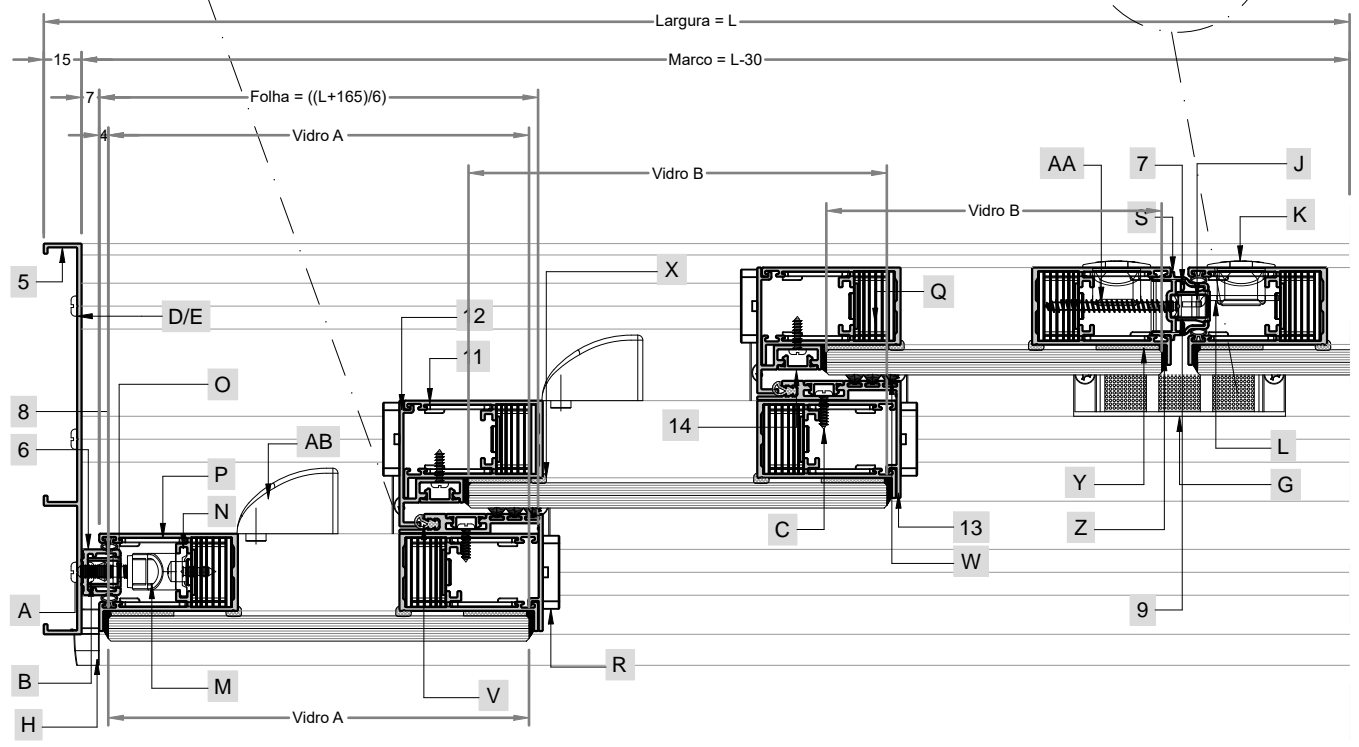
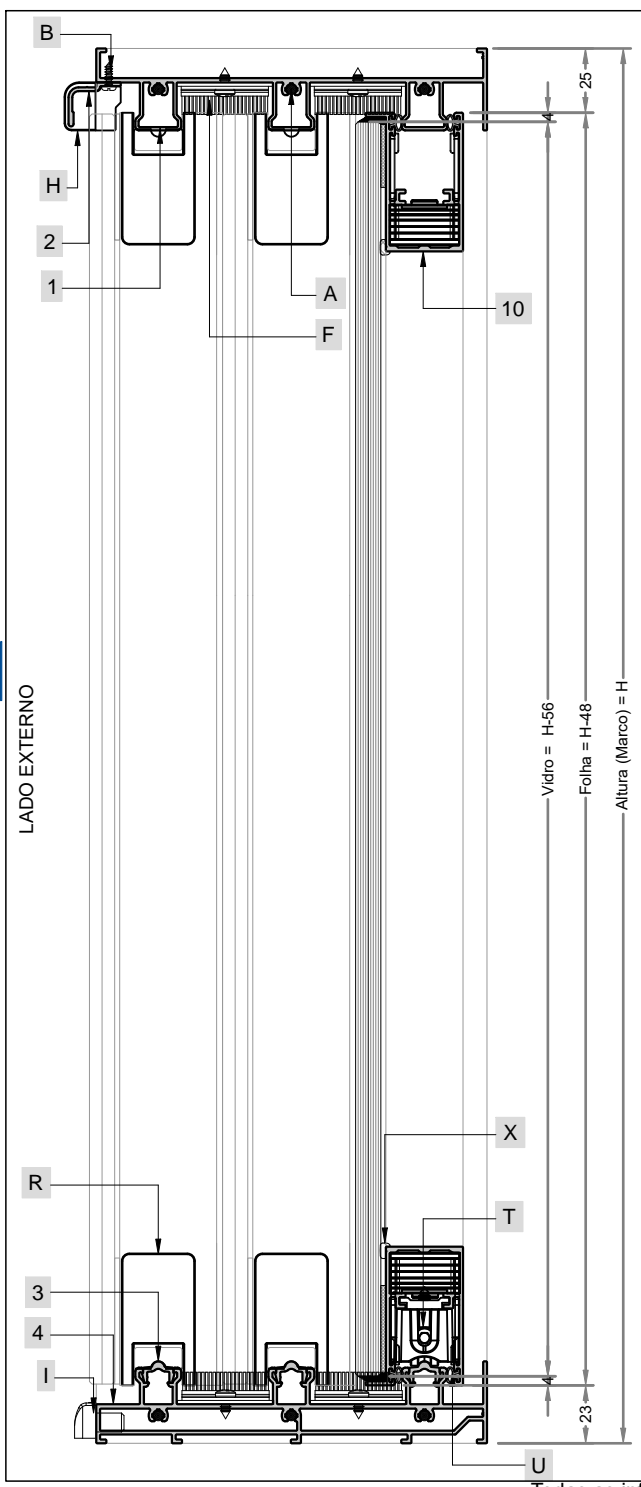

LADO EXTERNO

ESCALA: 1:3

Todas as informações são de propriedades da Olgacolor e estão sujeitas a alterações sem aviso prévio.

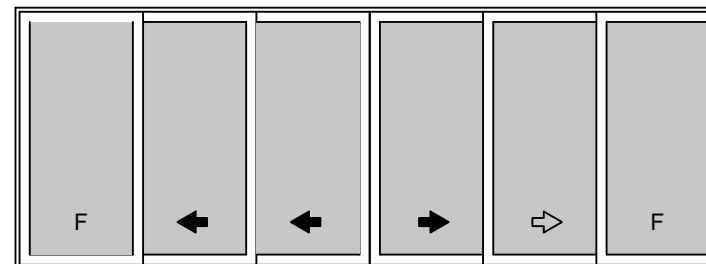
JANELA DE CORRER 06 FOLHAS
COM VIDRO COLADO

LISTA DE CORTE

POS.	ÍCONE	CÓDIGO	DESCRIÇÃO	ÂNGULO	DIREÇÃO	QUANT.	FÓRMULA
1		GSK050	Marco superior	90/90°	L	01	L-30
2		GSK006	Pingadeira	90/90°	L	01	L-36
3		GSK007	Trilho	90/90°	L	03	L-34
4		GSK051	Marco inferior	90/90°	L	01	L-30
5		GSK052	Marco lateral	90/90°	H	02	H
6		GSK004	Mata junta lateral	90/90°	H	02	H-62
7		GSK012	Mata junta central	90/90°	H	01	H-48
8		GSK005	Tampa de acabamento lateral	90/90°	H	02	H-62
9		GSK005	Tampa de acabamento central	90/90°	H	01	H-48
10		GSK043	Travessa superior e inferior	45/45°	L	12	((L+165)/6)
11		GSK043	Montate lateral e mão de amigo	45/45°	H	12	H-48
12		GSK044	Mão de amigo	90/90°	H	04	H-48
13		GSK045	Mão de amigo	90/90°	H	04	H-48
14		GSK410	Tampa de acabamento	90/90°	H	08	H-48

LISTA DE COMPONENTES

POS.	ÍCONE	CÓDIGO OLGA	DESCRIÇÃO	FÓRMULA	UN.
A		OLG-PAR0036	Parafuso autoatarraxante cabeça panela phillips 4,8x32mm - Inox	12	PÇ
B		OLG-PAR0020	Parafuso autoatarraxante cabeça panela phillips 4,2 x 9,5 mm - Inox	((L+H*2)/250)	PÇ
C		OLG-PAR0021	Parafuso autoatarraxante cabeça panela phillips 4,2 x 13 mm - Inox	((H*8)/250)	PÇ
D		OLG-VED0152	Junta de vedação superior	02	PÇ
E		OLG-VED0151	Junta de vedação inferior	02	PÇ
F		OLG-NYL0087	Vedação inferior / superior - 02 escovas	08	PÇ
G		OLG-NYL0088	Vedação inferior / superior - 03 escovas	02	PÇ
H		OLG-NYL0048	Tampa da pingadeira	01	PAR
I		OLG-NYL0034	Dreno com portinhola	02	CJ
J		OLG-FEC0114	Contra fecho	01	PÇ
K		CONSULTAR TABELA	Fecho concha	02	PÇ
L		OLG-FEC0138	Lingueta	01	PÇ
M		OLG-FEC0125-PTO	Bico fecho bulón regulável	04	PÇ
N		OLG-FEC0127-PTO	Fixador trava da folha fixa	08	PÇ
O		OLG-FEC0116-INX	Contra fecho inox	04	PÇ
P		OLG-CON0001-PTO	Conexão de alinhamento da folha	48	PÇ
Q		OLG-CON0024-NAT	Macho de conexão 45° - 26,6x14,5	24	PÇ
R		OLG-NYL0003	Kit guia deslizante	08	CJ
S		OLG-NYL0020	Kit vedação central	01	CJ
T		CONSULTAR TABELA	Roldana	12	PÇ
U		OLG-VED0010-PTO	Guarnição perimetral da folha	((L*4)+(H*6))	MM
V		OLG-VED0011-PTO	Guarnição mão de amigo	H*4	MM
W		CONSULTAR TABELA	Escova quadrifin	H*12	MM
X		OLG-VED144-PTO	Guarnição interna da folha	((L*2)+(H*12))	MM
Y		OLG-VED0143	Fita dupla face	((L*2)+(H*12))	MM
Z		OLG-VED0145	Silicone estrutural	Variável	TB
AA		OLG-PAR0029	Parafuso autoatarraxante cabeça panela phillips 4,2x50mm - Inox	H/250	PÇ
AB		OLG-NYL0031	Batedeira universal	08	PÇ
AC		OLG-NYL0021-PTO	Calço da folha fixa	04	PÇ

ROLDANAS

CÓDIGO OLGA	CARGA	COR
OLG-ROL0001-001	40KG	S/A
OLG-ROL0002-001	80KG	S/A
OLG-ROL0003-001	200KG	S/A

VIDROS

VIDRO	LARGURA	ALTURA	QUANT.
A	((L/6)+19)	H-56	02
B	((L/6)-2)	H-56	04

FECHOS

CÓDIGO OLGA	TIPO	COR
OLG-FEC0001-BCO	SEM CHAVE	BRANCO
OLG-FEC0001-PRA	SEM CHAVE	PRATA
OLG-FEC0001-PTO	SEM CHAVE	PRETO
OLG-FEC0002-BCO	COM CHAVE	BRANCO
OLG-FEC0002-PRA	COM CHAVE	PRATA
OLG-FEC0002-PTO	COM CHAVE	PRETO
OLG-FEC0003-BCO	CEGA	BRANCO
OLG-FEC0003-PRA	CEGA	PRATA
OLG-FEC0003-PTO	CEGA	PRETO

ESCOVAS

CÓDIGO OLGA	DIMENSÃO	VIDRO
OLG-VED0132-PTO	5X10	06MM
OLG-VED0131-PTO	5X8	08MM
OLG-VED0129-PTO	5X6	10MM

Todas as informações são de propriedades da Olgacolor e estão sujeitas a alterações sem aviso prévio.

PORTA DE CORRER 02 FOLHAS COM VIDRO COLADO

VIDROS
Sistema atende vidros de 06mm, 08mm e 10mm de espessura

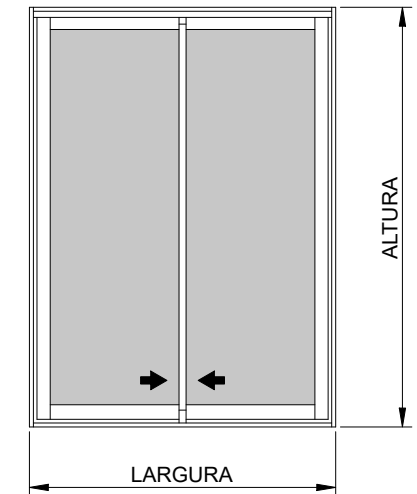

ELEVAÇÃO VISTA EXTERNA
SEM ESCALA

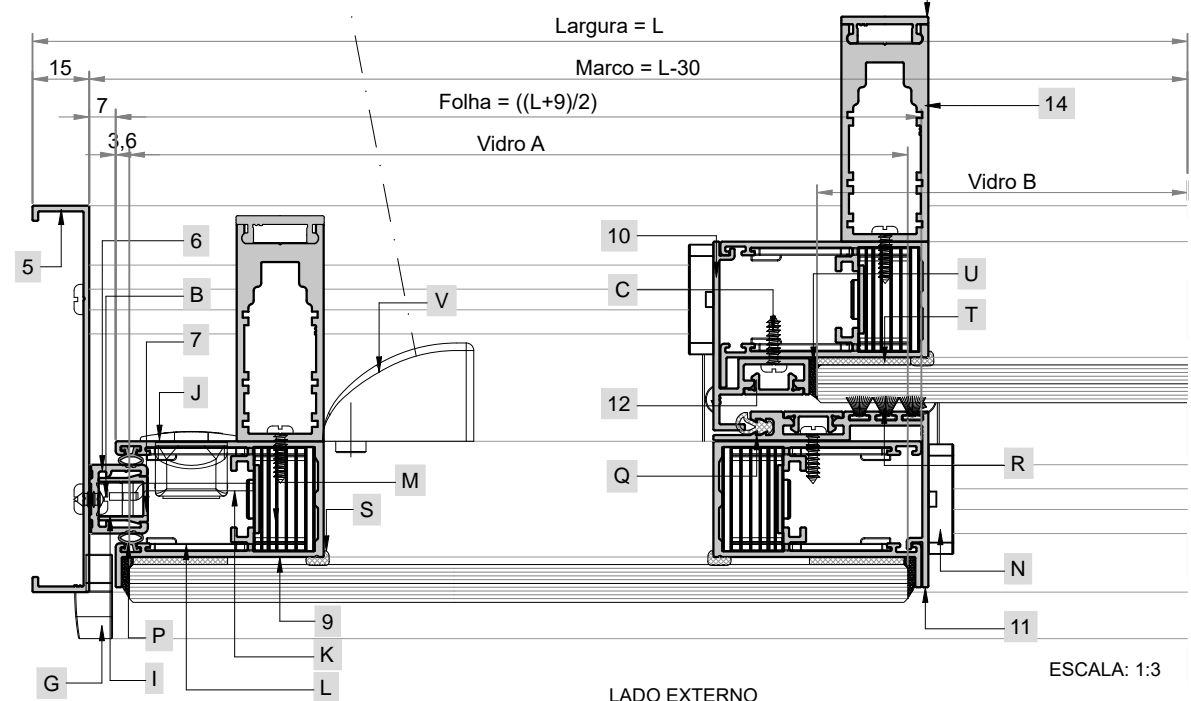

LADO EXTERNO

ESCALA: 1:3

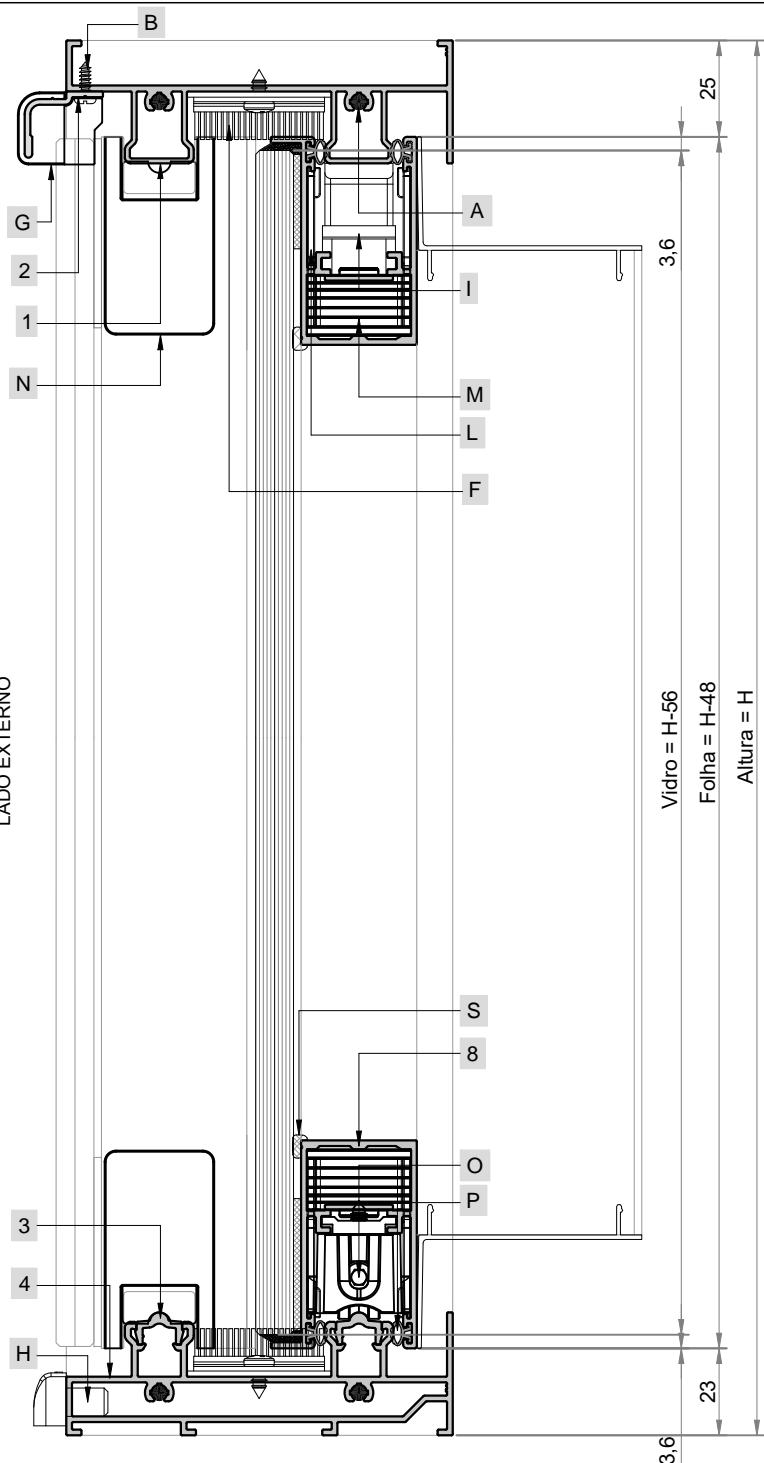

LADO EXTERNO



Todas as informações são de propriedades da Olgacolor e estão sujeitas a alterações sem aviso prévio.

LISTA DE CORTE

POS.	ÍCONE	CÓDIGO	DESCRIÇÃO	ANGULO	DIREÇÃO	QUANT.	FÓRMULA
1		GSK040	Marco superior	90/90°	L	01	L-30
2		GSK006	Pingadeira	90/90°	L	01	L-36
3		GSK007	Trilho	90/90°	L	02	L-34
4		GSK041	Marco inferior	90/90°	L	01	L-30
5		GSK042	Marco lateral	90/90°	H	02	H
6		GSK004	Mata junta lateral	90/90°	H	02	H-62
7		GSK005	Tampa de acabamento	90/90°	H	02	H-62
8		GSK043	Travessa superior e inferior	45/45°	L	04	((L+9)/2)
9		GSK043	Montate lateral e mão de amigo	45/45°	H	04	H-48
10		GSK044	Mão de amigo	90/90°	H	01	H-48
11		GSK045	Mão de amigo	90/90°	H	01	H-48
12		GSK410	Tampa de acabamento	90/90°	H	02	H-48
13		GSK046	Tampa do reforço	90/90°	H	03	H-48
14		GSK047	Reforço	90/90°	H	03	H-48

PORTA DE CORRER 02 FOLHAS COM VIDRO COLADO

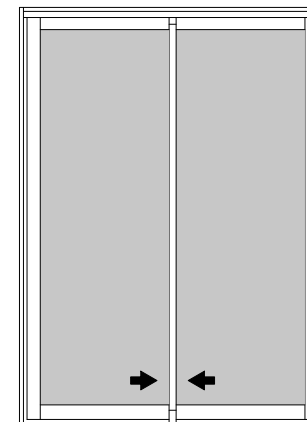

LISTA DE COMPONENTES

POS.	ÍCONE	CÓDIGO OLGA	DESCRIÇÃO	FÓRMULA	UN.
A		OLG-PAR0036	Parafuso autoatarraxante cabeça panela phillips 4,8x32mm - Inox	08	PÇ
B		OLG-PAR0020	Parafuso autoatarraxante cabeça panela phillips 4,2 x 9,5 mm - Inox	((L+H*2)/250)	PÇ
C		OLG-PAR0021	Parafuso autoatarraxante cabeça panela phillips 4,2 x 13 mm - Inox	((H*5)/250)	PÇ
D		OLG-VED0154	Junta de vedação marco superior	02	PÇ
E		OLG-VED0153	Junta de vedação marco inferior	02	PÇ
F		OLG-NYL0087	Vedação inferior / superior - 02 escovas	02	PÇ
G		OLG-NYL0048	Tampa da pingadeira	01	PAR
H		OLG-NYL0034	Dreno com portinhola	01	CJ
I		OLG-FEC0114	Contra fecho	02	PÇ
J		CONSULTAR TABELA	Fecho concha	02	PÇ
K		OLG-FEC0138	Lingueta	02	PÇ
L		OLG-CON0001-PTO	Conexão de alinhamento da folha	16	PÇ
M		OLG-CON0024-NAT	Macho de conexão 45° - 26,6x14,5	08	PÇ
N		OLG-NYL0003	Kit guia deslizante	02	CJ
O		CONSULTAR TABELA	Roldana	04	PÇ
P		OLG-VED0010-PTO	Guarnição perimetral da folha	((L*4)+(H*4))	MM
Q		OLG-VED0011-PTO	Guarnição mão de amigo	H	MM
R		CONSULTAR TABELA	Escova quadrifin	H*3	MM
S		OLG-VED144-PTO	Guarnição interna da folha	((L*2)+(H*4))	MM
T		OLG-VED0143	Fita dupla face	((L*2)+(H*4))	MM
U		OLG-VED0145	Silicone estrutural	Variável	TB
V		OLG-NYL0031	Batedeira universal	02	PÇ
W		Em desenvolvimento	Tampa do reforço	06	PÇ

ROLDANAS

CÓDIGO OLGA	CARGA	COR
OLG-ROL0002-001	80KG	S/A
OLG-ROL0003-001	200KG	S/A

VIDROS

VIDRO	LARGURA	ALTURA	QUANT.
A	((L/2)-3)	H-56	01
B	((L/2)-25)	H-56	01

FECHOS

CÓDIGO OLGA	TIPO	COR
OLG-FEC0004-BCO	SEM CHAVE	BRANCO
OLG-FEC0004-PRA	SEM CHAVE	PRATA
OLG-FEC0004-PTO	SEM CHAVE	PRETO
OLG-FEC0005-BCO	COM CHAVE	BRANCO
OLG-FEC0005-PRA	COM CHAVE	PRATA
OLG-FEC0005-PTO	COM CHAVE	PRETO

ESCOVAS

CÓDIGO OLGA	DIMENSÃO	VIDRO
OLG-VED0132-PTO	5X10	06MM
OLG-VED0131-PTO	5X8	08MM
OLG-VED0129-PTO	5X6	10MM

Todas as informações são de propriedades da Olgacolor e estão sujeitas a alterações sem aviso prévio.

APLICAÇÃO DE GUARNIÇÕES

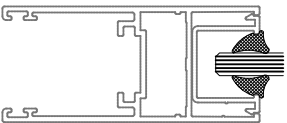
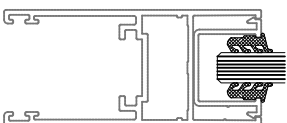
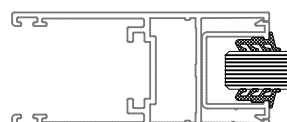
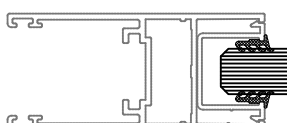
APLICAÇÃO	ESPESSURA VIDRO	GUARNIÇÃO INTERNA	GUARNIÇÃO EXTERNA
	06mm	OLG-VED0165 (BT-523)	OLG-VED0165 (BT-523)
	08mm	OLG-VED0052 (GUA-256)	OLG-VED0052 (GUA-256)
	10mm	OLG-VED0052 (GUA-256)	OLG-VED0052 (GUA-256)
	12mm	OLG-VED0053 (GUA-259)	OLG-VED0053 (GUA-259)

⚠ ATENÇÃO À POSIÇÃO
DAS FOLHAS!

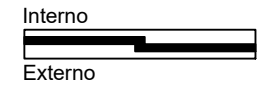
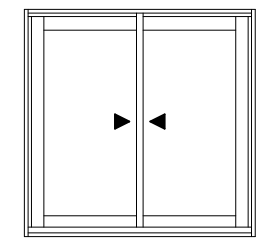

GSK002

Marco Inferior 2 Planos

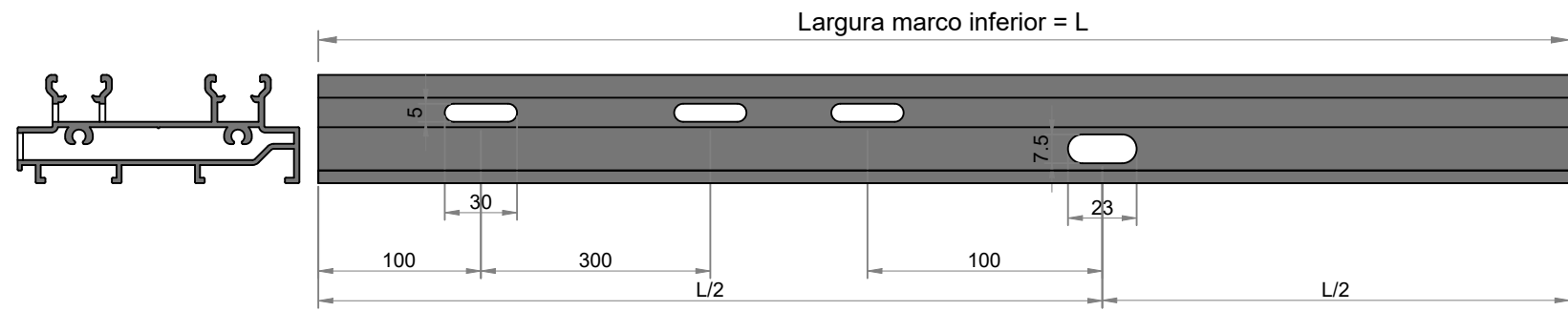
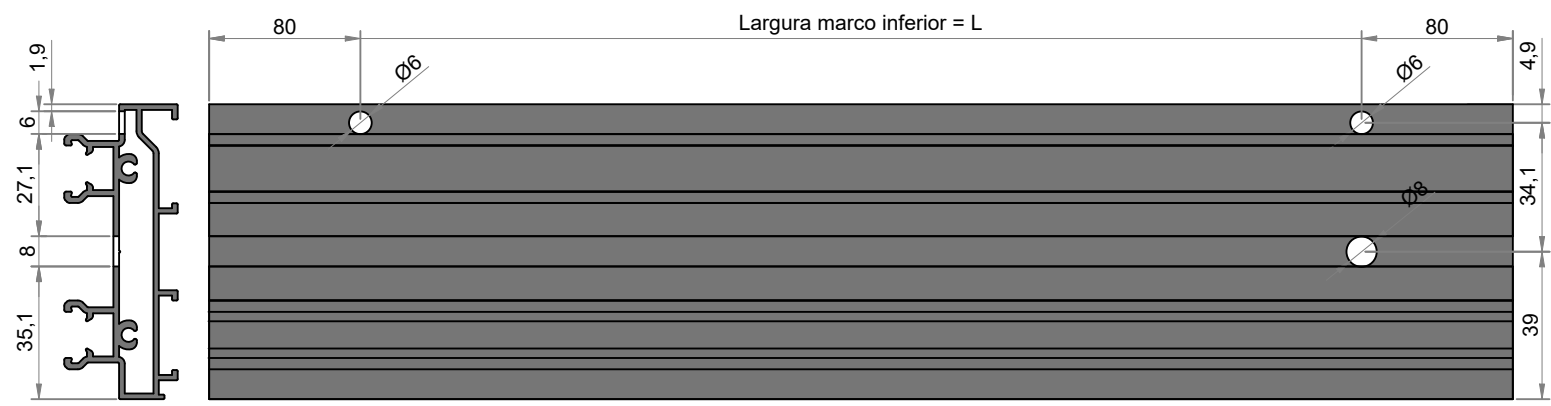

Todas as informações são de propriedades da Olgacolor e estão sujeitas a alterações sem aviso prévio.

⚠ ATENÇÃO À POSIÇÃO
DAS FOLHAS!

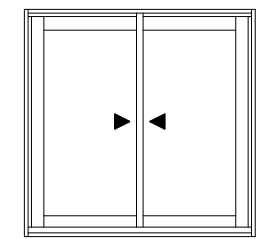

Interno
Externo

GSK002

Marco Inferior 2 Planos

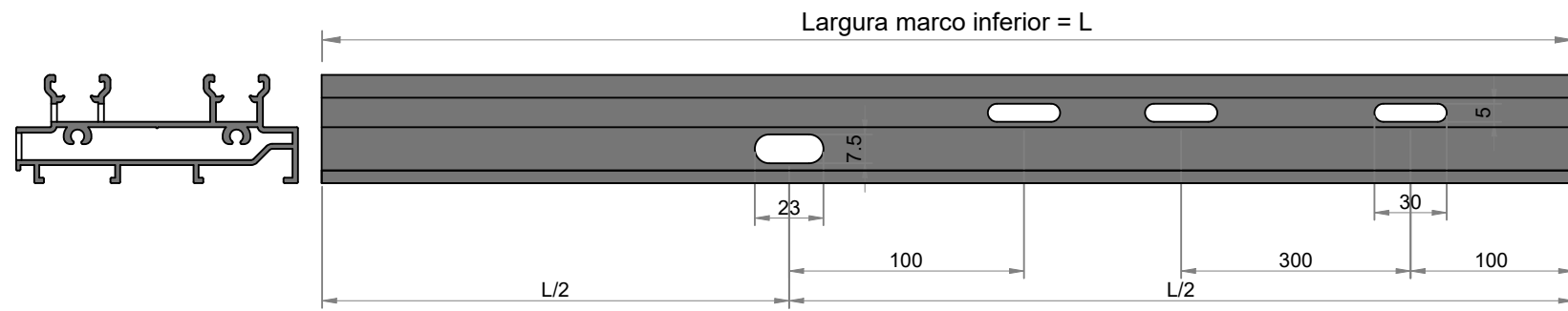
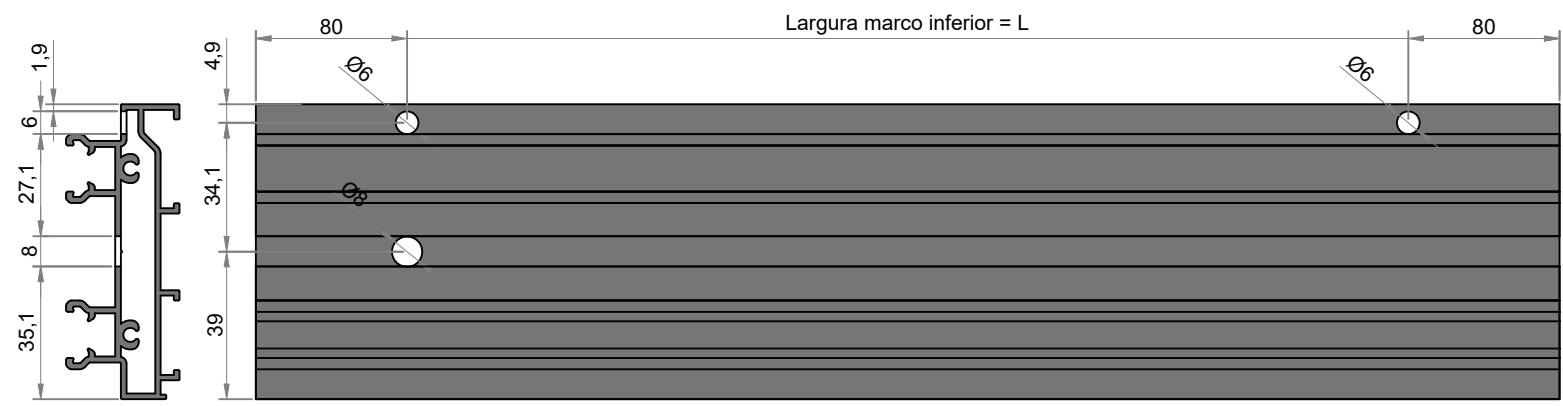

Todas as informações são de propriedades da Olgacolor e estão sujeitas a alterações sem aviso prévio.

GSK014

Marco Inferior 3 Planos

 ATENÇÃO À POSIÇÃO
DAS FOLHAS!

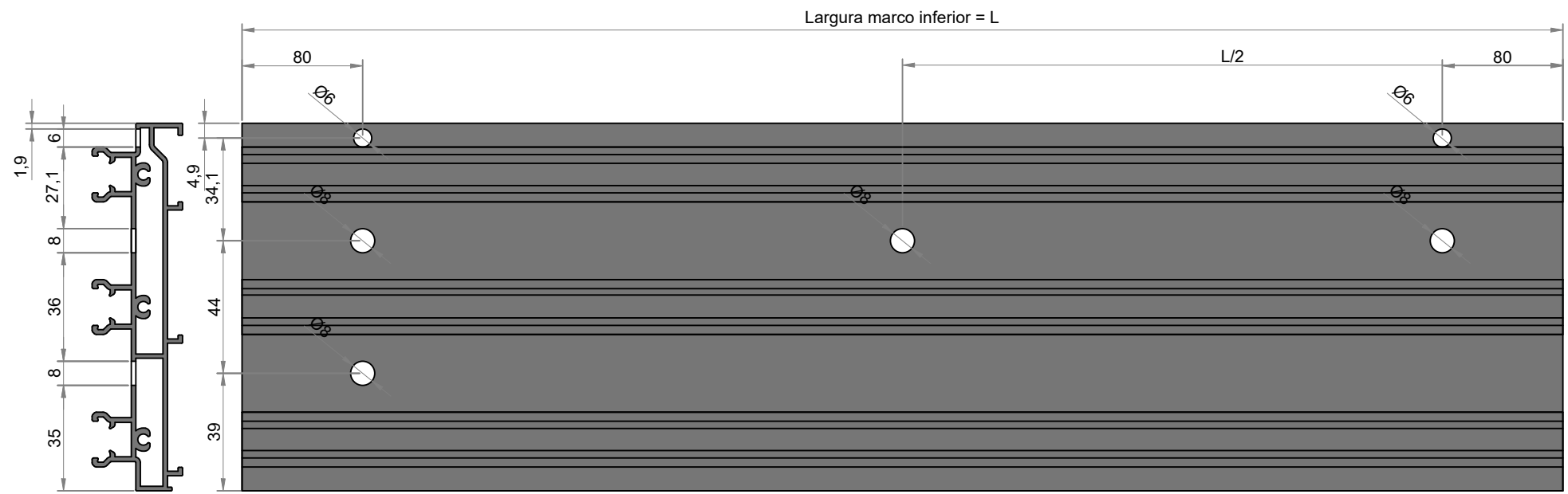
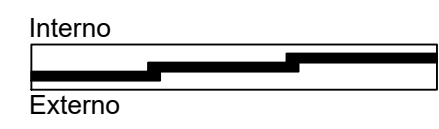
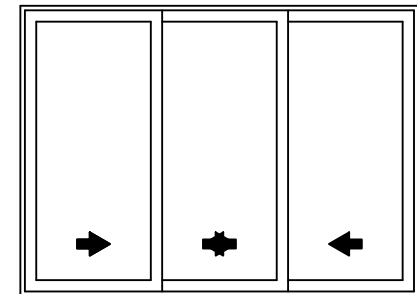

GSK014

Marco Inferior 3 Planos

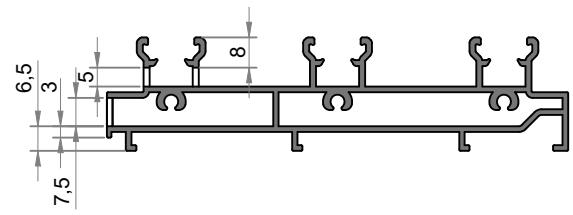
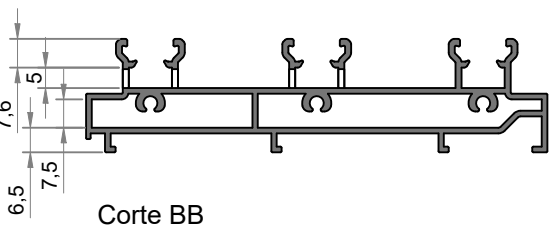
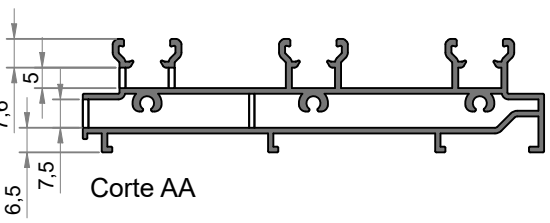

⚠ ATENÇÃO À POSIÇÃO
DAS FOLHAS!

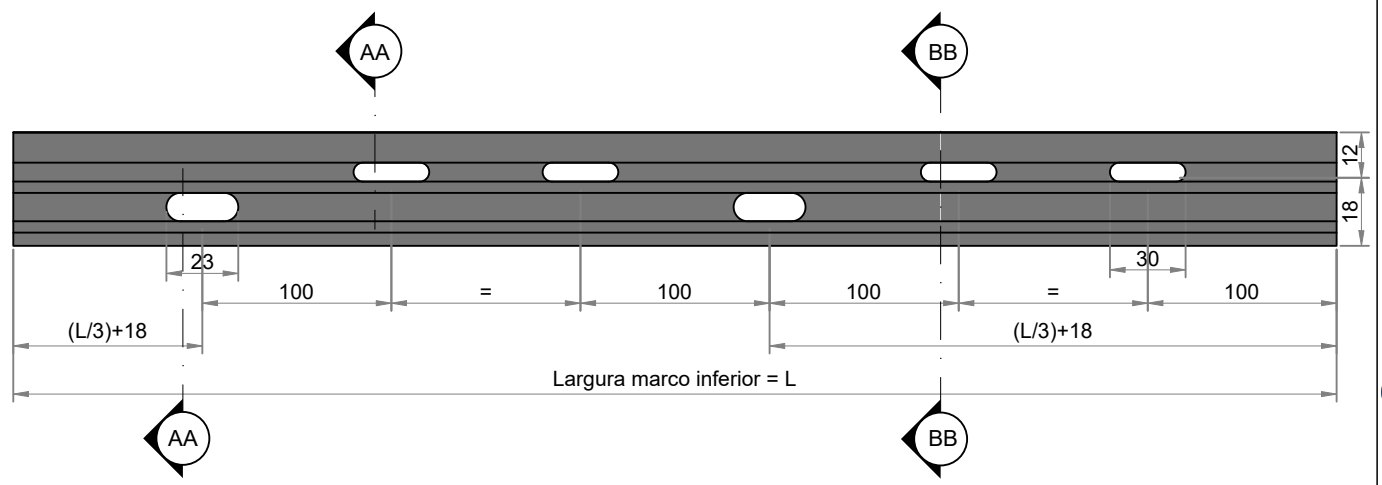
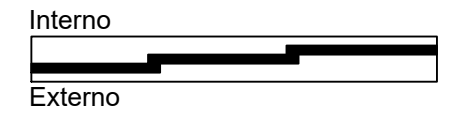
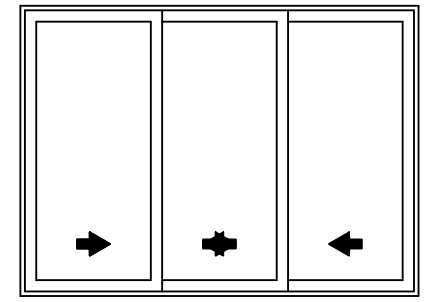

GSK014

Marco Inferior 3 Planos

⚠ ATENÇÃO À POSIÇÃO
DAS FOLHAS!

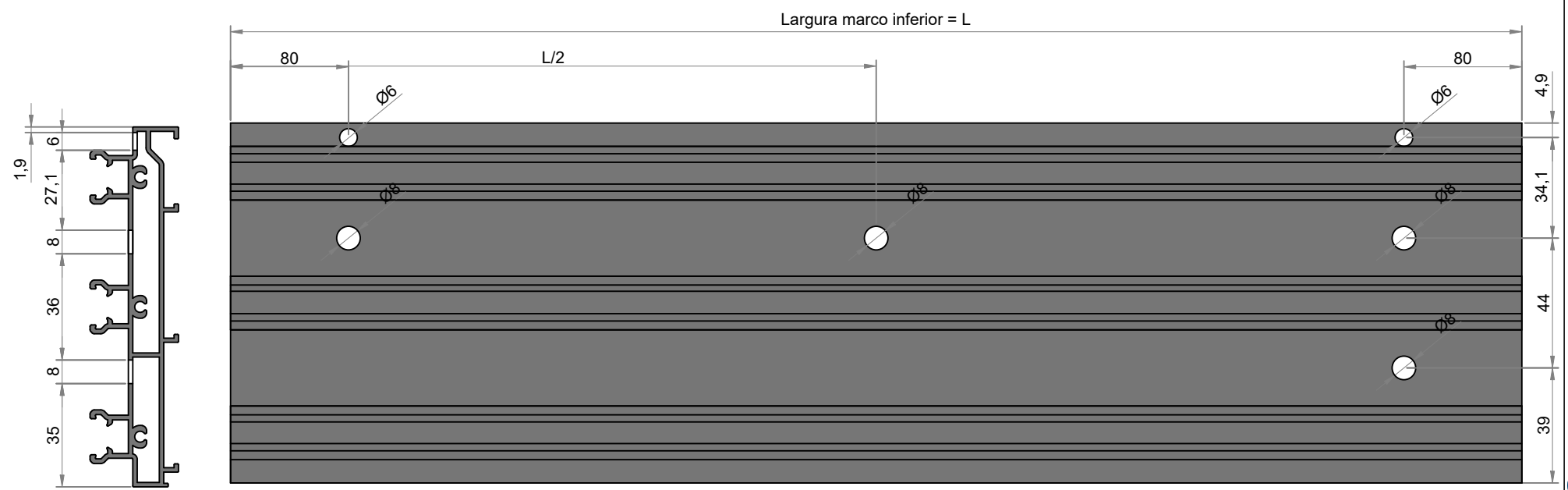
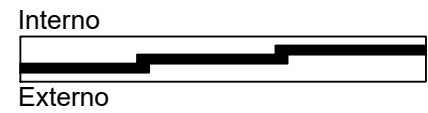
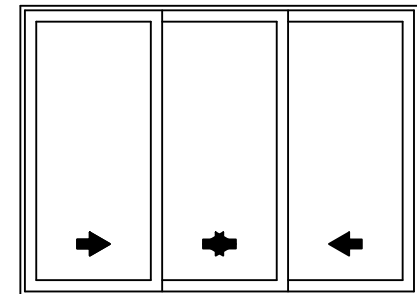

GSK014

Marco Inferior 3 Planos

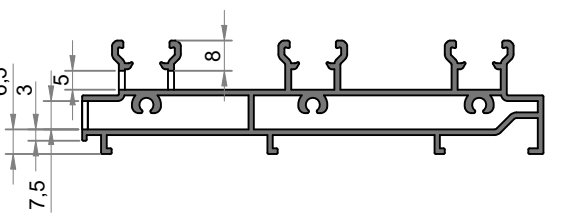
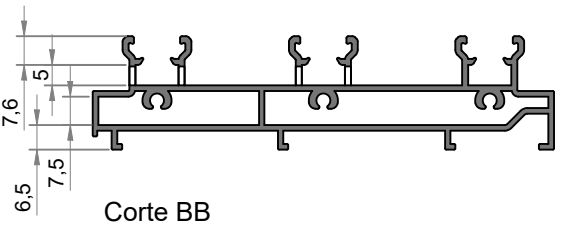
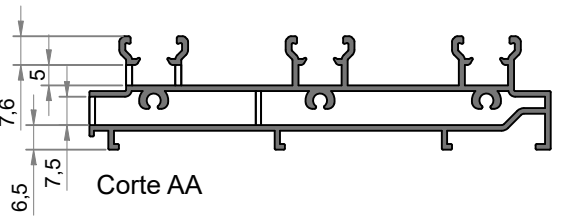

! ATENÇÃO À POSIÇÃO DAS FOLHAS!

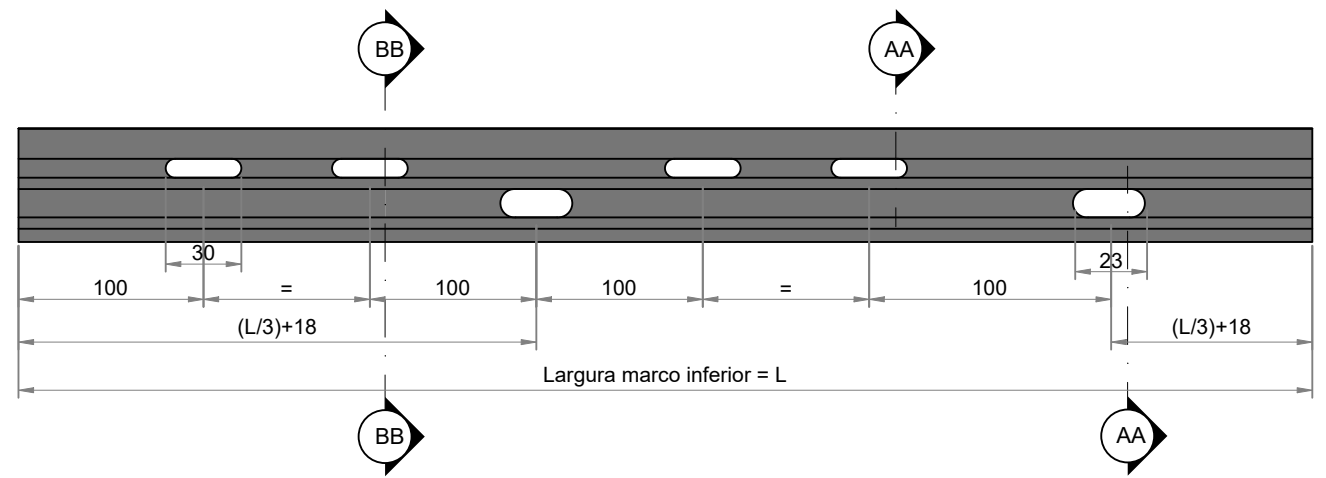
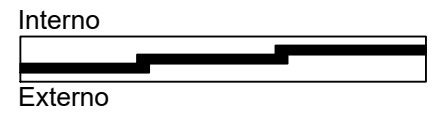
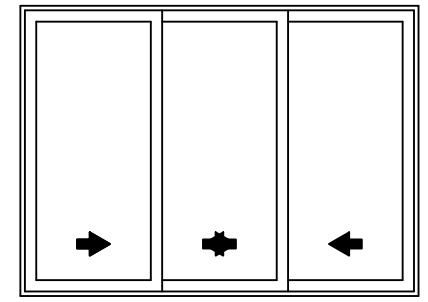

⚠ ATENÇÃO À POSIÇÃO
DAS FOLHAS!

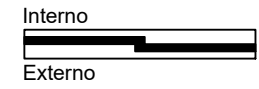
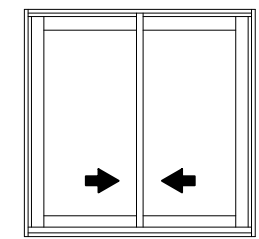

GSK041

Marco Inferior Vidro Colado
2 Planos

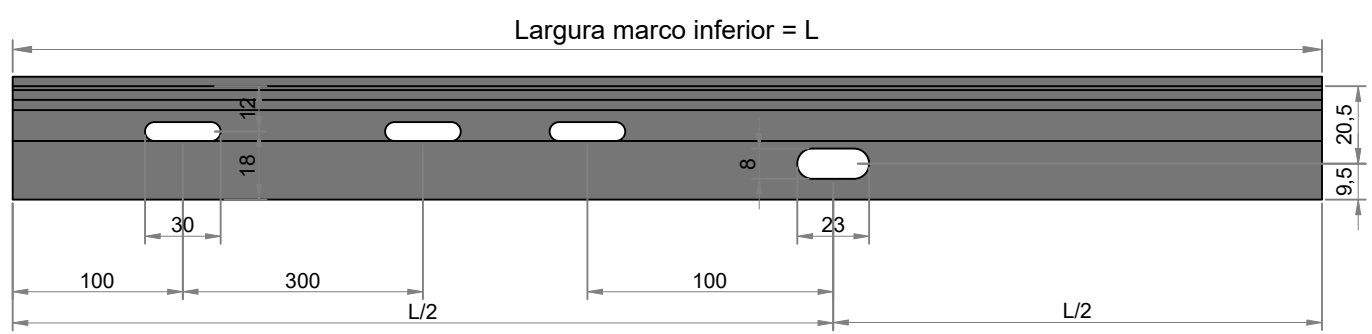
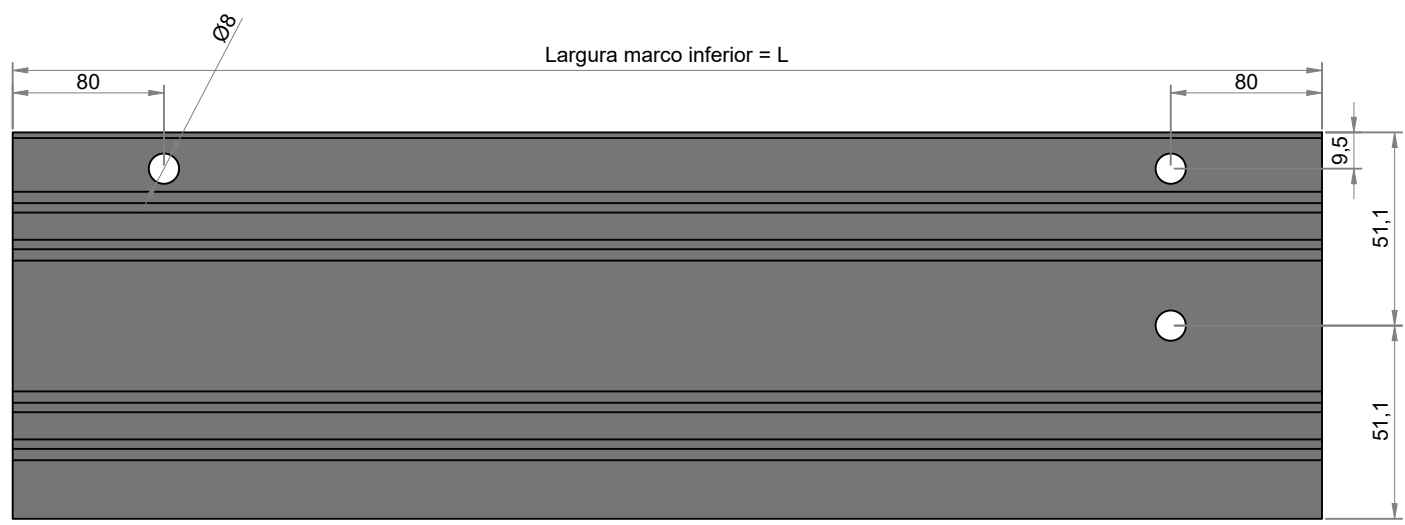
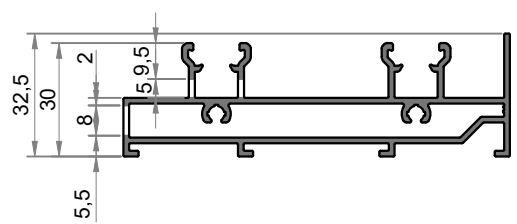
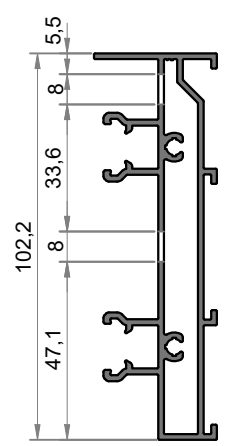

Todas as informações são de propriedades da Olgacolor e estão sujeitas a alterações sem aviso prévio.



ATENÇÃO À POSIÇÃO
DAS FOLHAS!

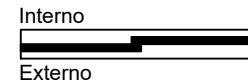
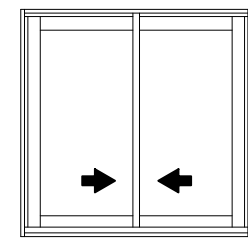

GSK041

Marco Inferior Vidro Colado
2 Planos

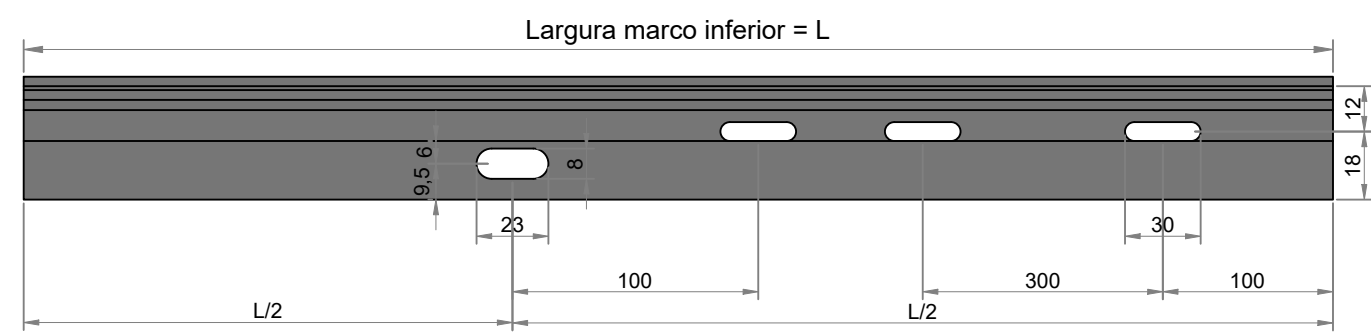
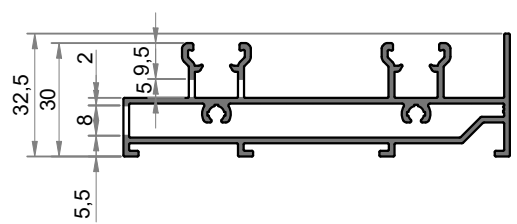
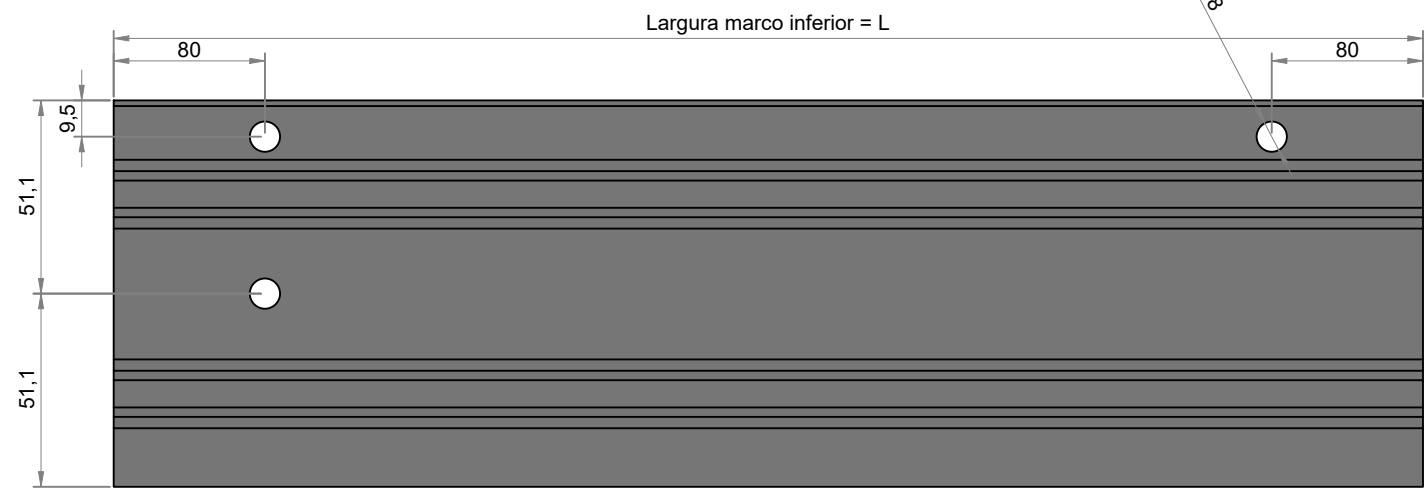
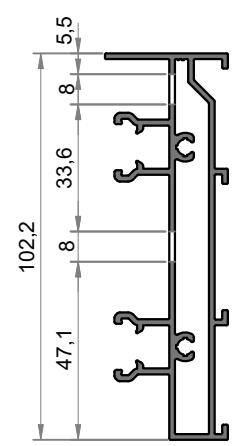

Todas as informações são de propriedades da Olgacolor e estão sujeitas a alterações sem aviso prévio.

GSK041

Marco Inferior Vidro Colado
2 Planos



ATENÇÃO À POSIÇÃO
DAS FOLHAS!

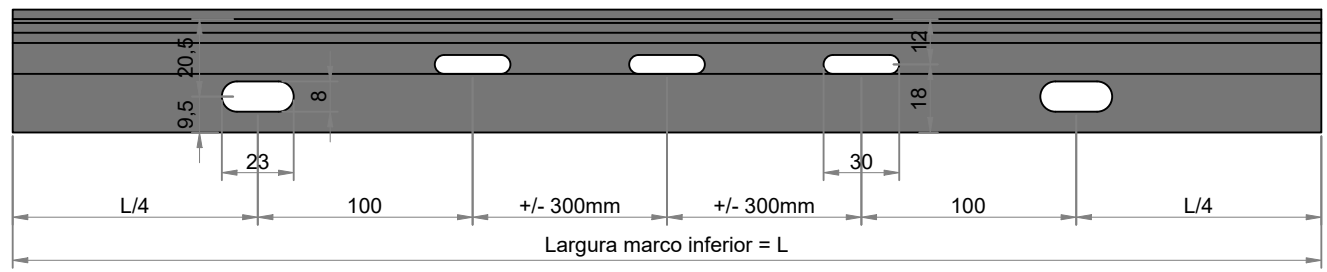
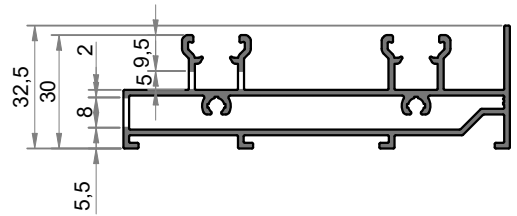
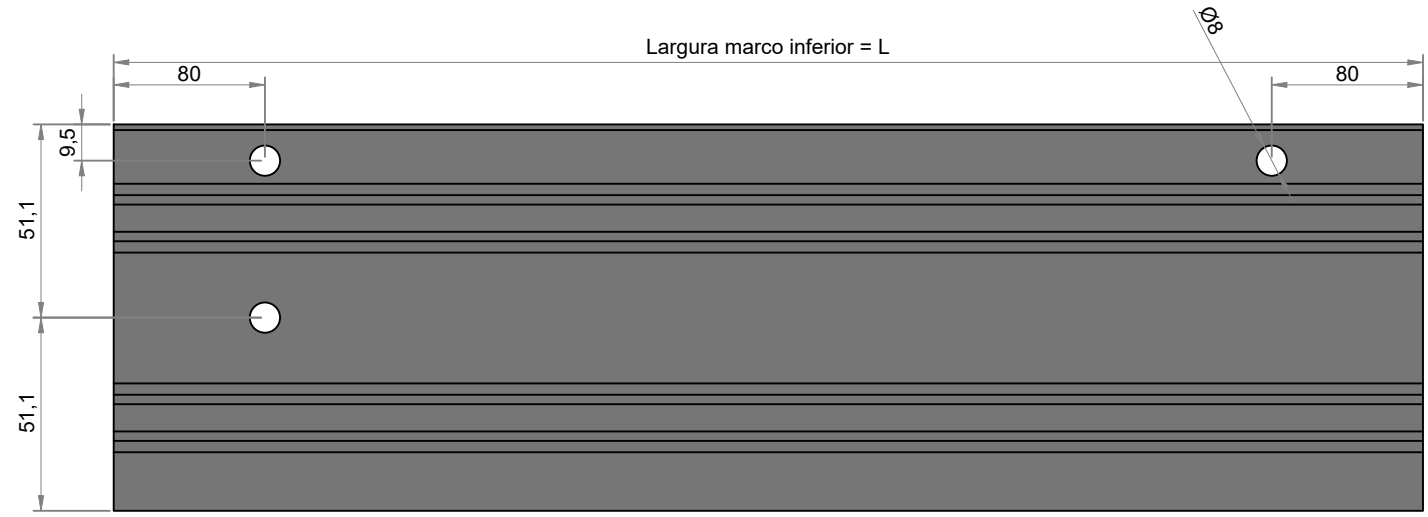
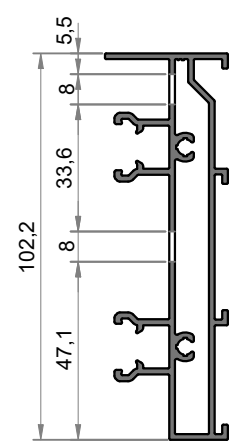
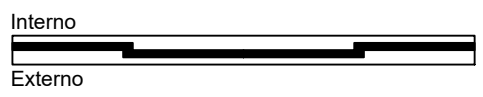
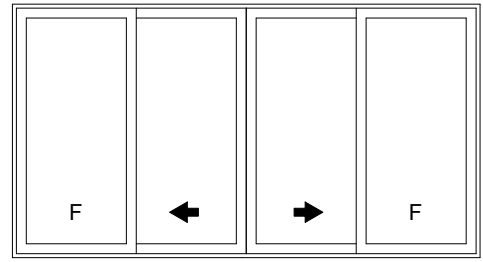

Todas as informações são de propriedades da Olgacolor e estão sujeitas a alterações sem aviso prévio.

GSK041

Marco Inferior Vidro Colado
2 Planos



ATENÇÃO À POSIÇÃO
DAS FOLHAS!

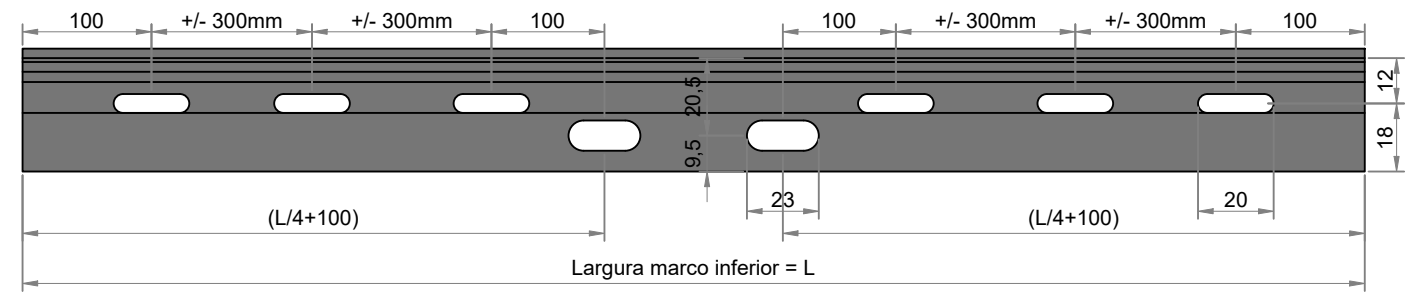
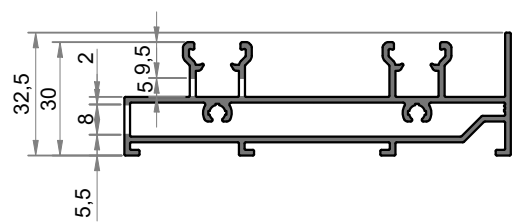
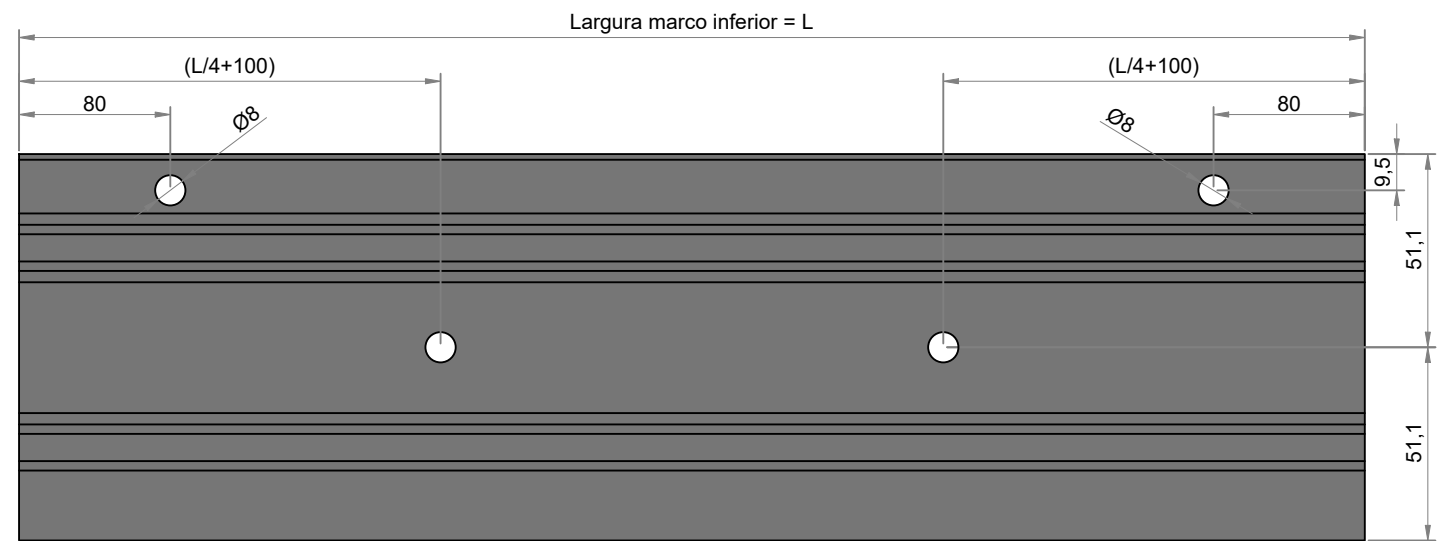
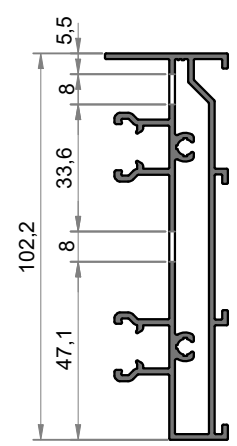
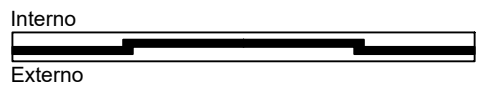
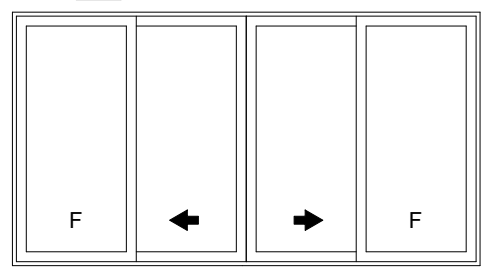

Todas as informações são de propriedades da Olgacolor e estão sujeitas a alterações sem aviso prévio.

GSK051

Marco Inferior Vidro Colado
3 Planos

⚠ ATENÇÃO À POSIÇÃO
DAS FOLHAS!

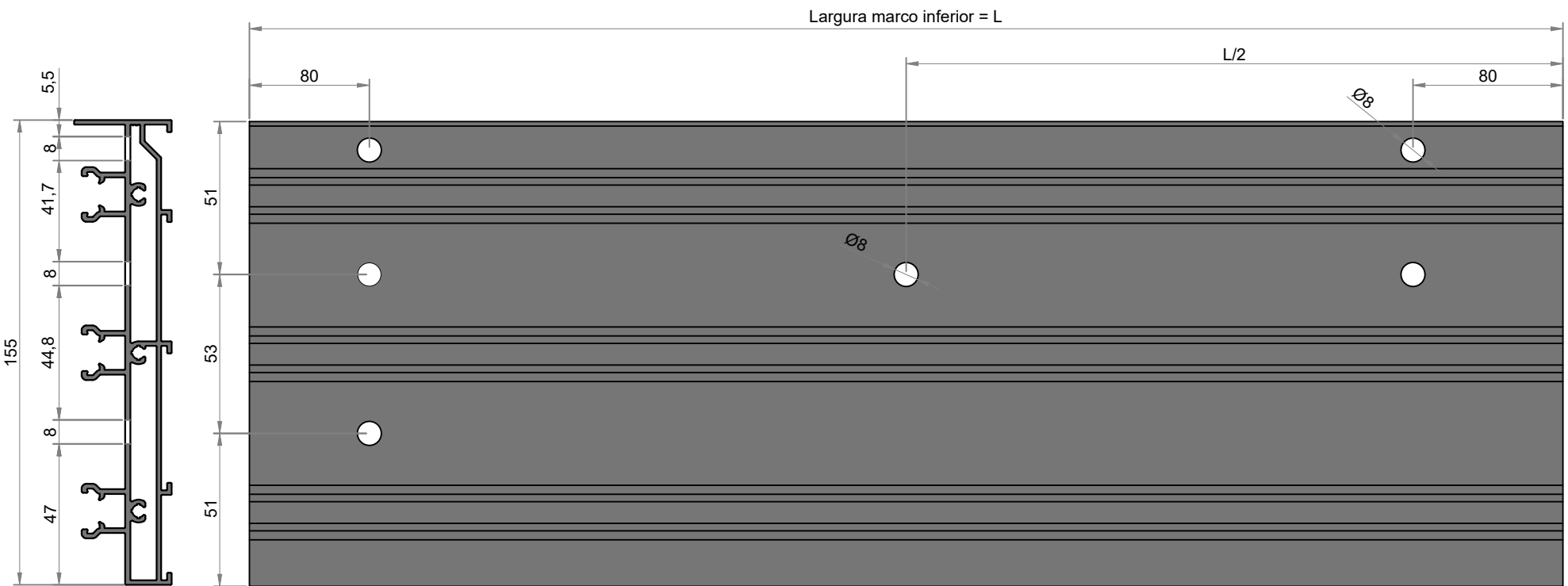
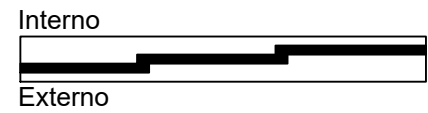
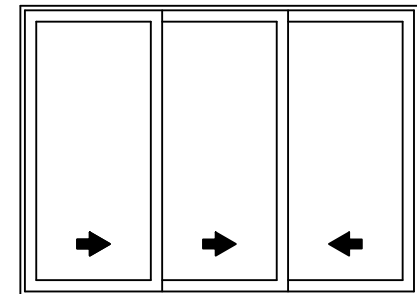

GSK051

Marco Inferior Vidro Colado
3 Planos

 ATENÇÃO À POSIÇÃO
DAS FOLHAS!

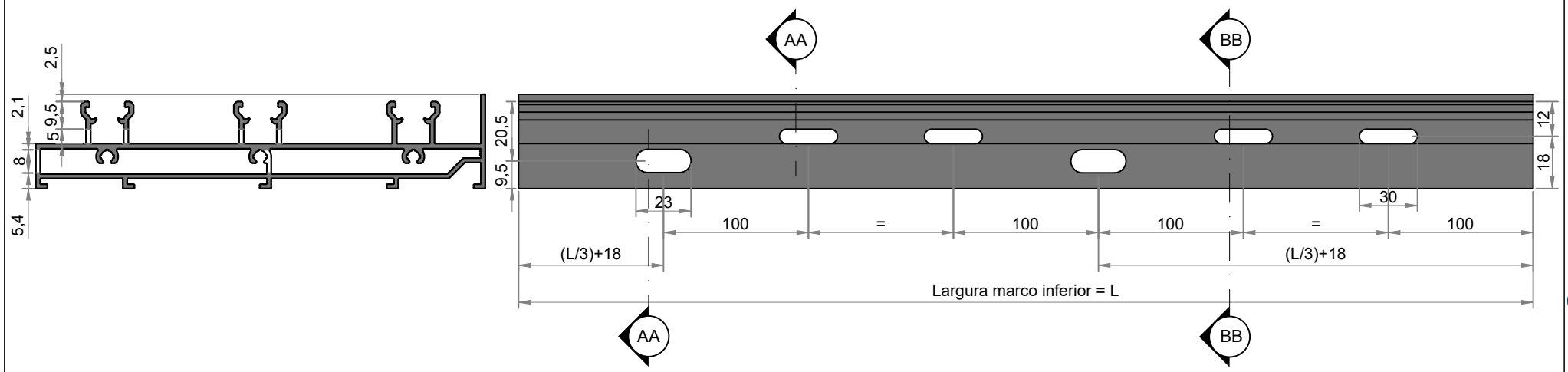
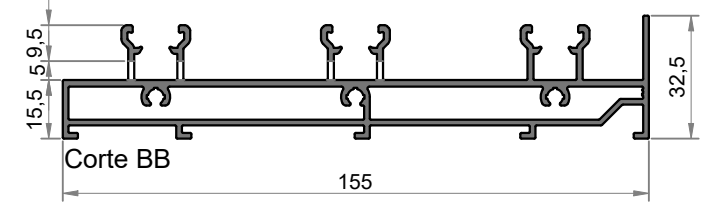
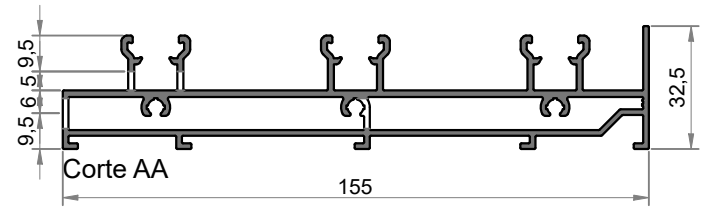
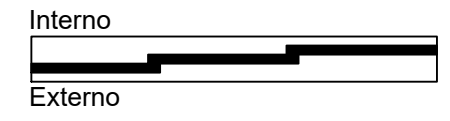
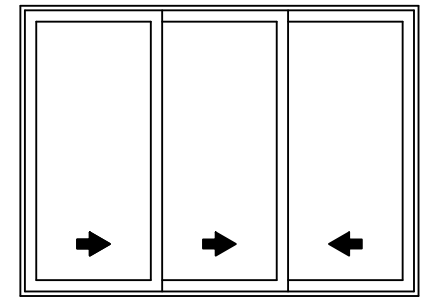

GSK051

Marco Inferior Vidro Colado
3 Planos

 ATENÇÃO À POSIÇÃO
DAS FOLHAS!

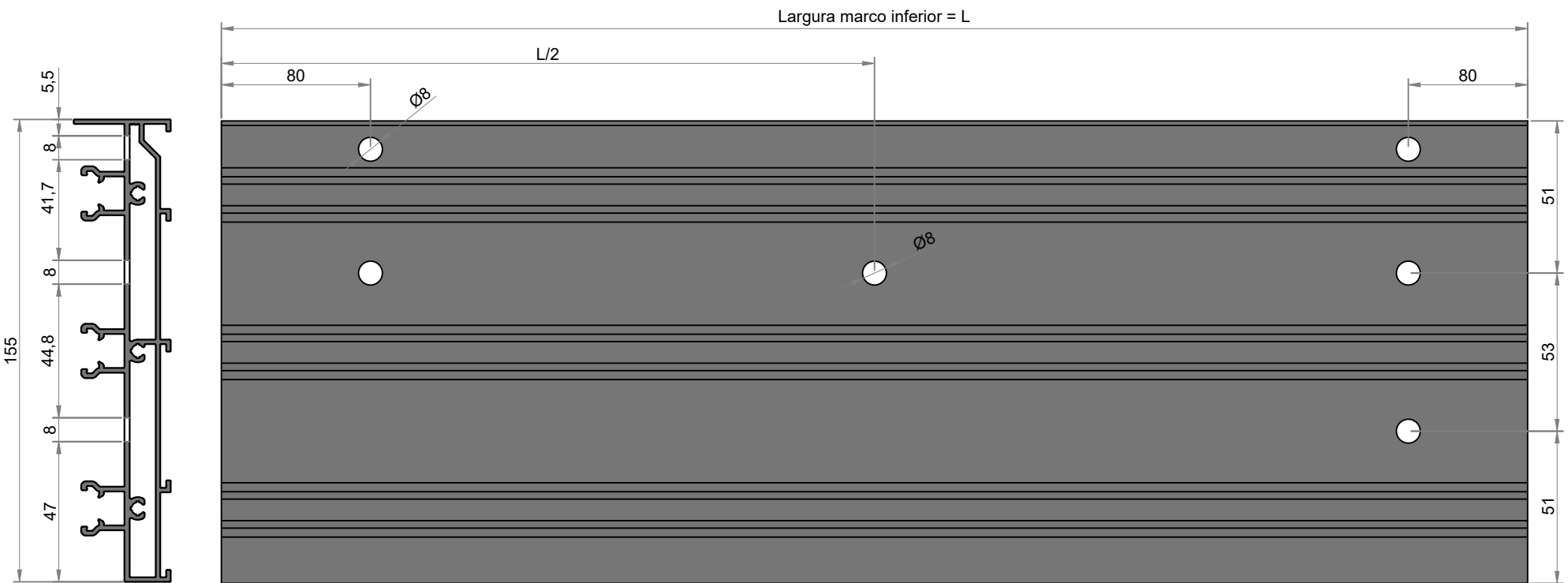
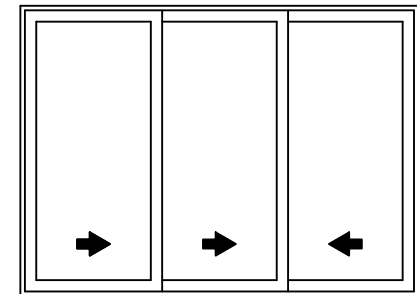

GSK051

Marco Inferior Vidro Colado
3 Planos

 ATENÇÃO À POSIÇÃO
DAS FOLHAS!

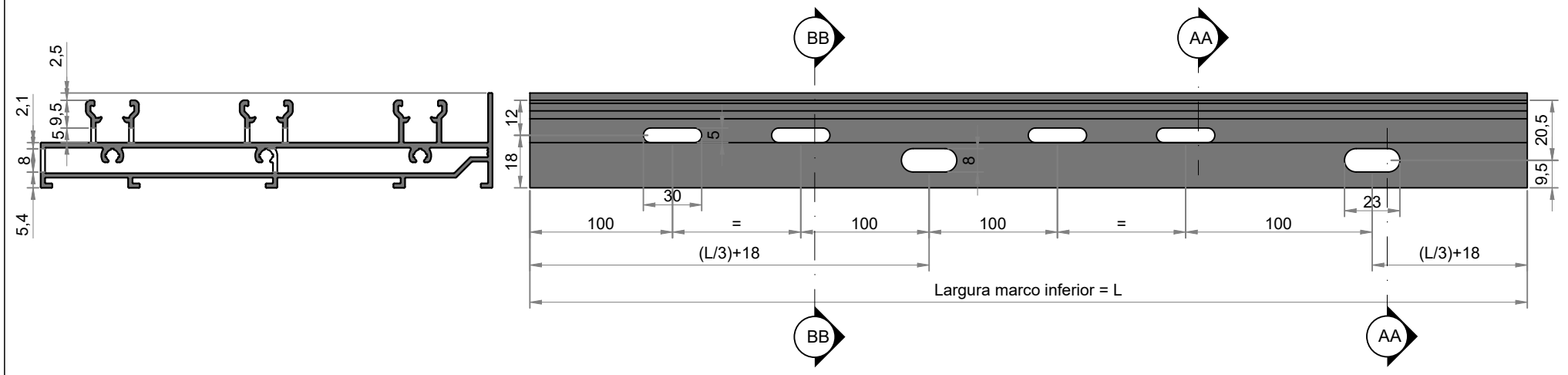
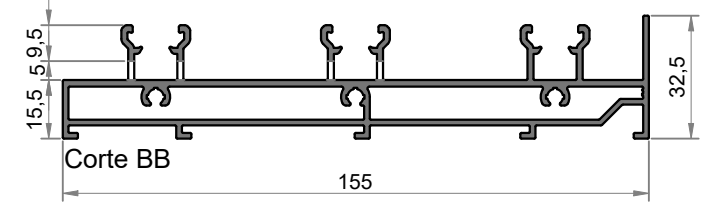
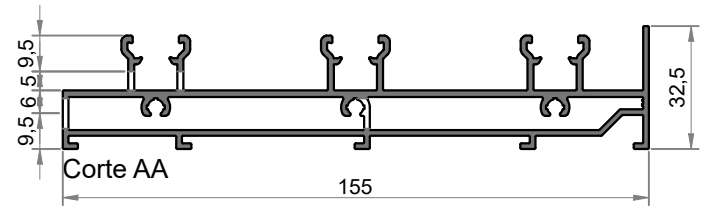
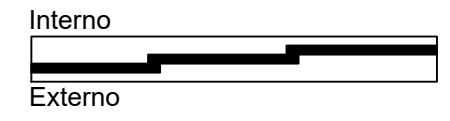
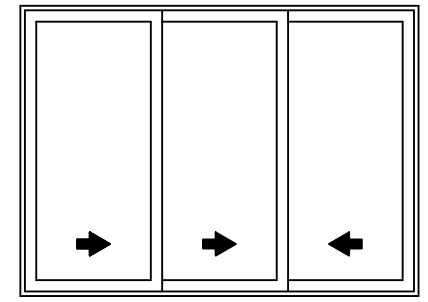

GSK003

Marco Lateral 2 Planos



Todas as informações são de propriedades da Olgacolor e estão sujeitas a alterações sem aviso prévio.

GSK015

Marco Lateral 3 Planos

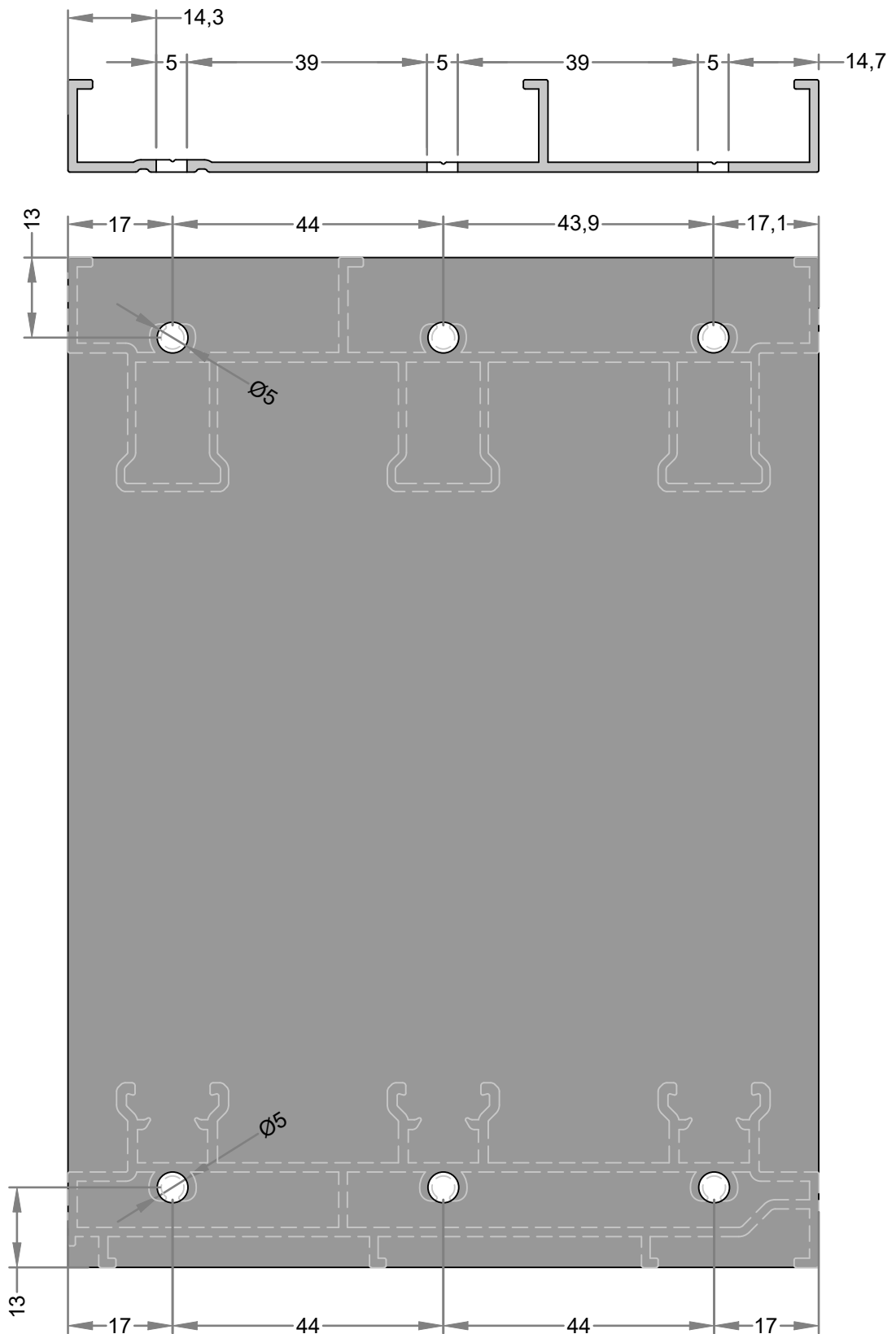

Todas as informações são de propriedades da Olgacolor e estão sujeitas a alterações sem aviso prévio.

GSK042

Marco Lateral 2 Planos

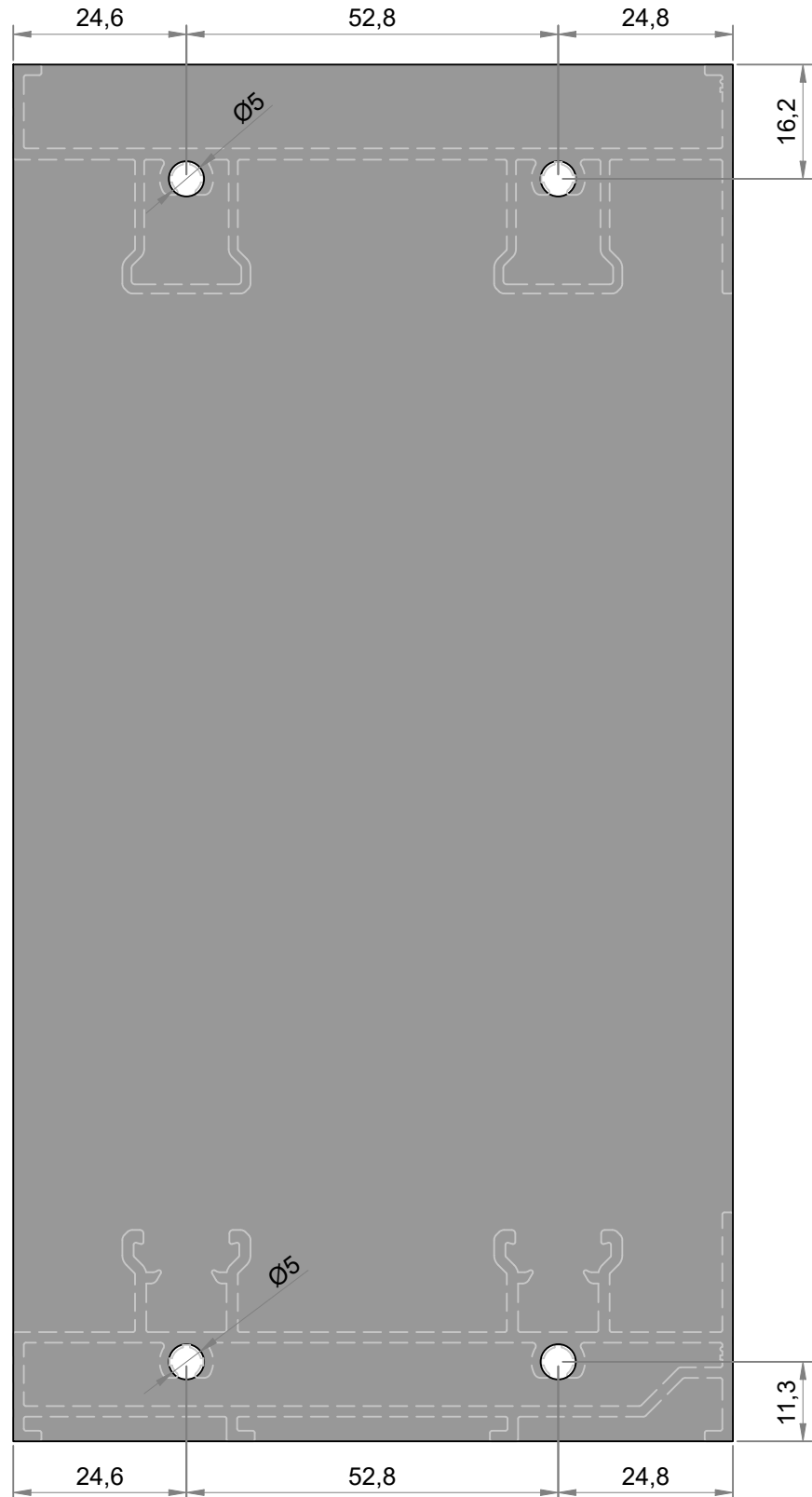
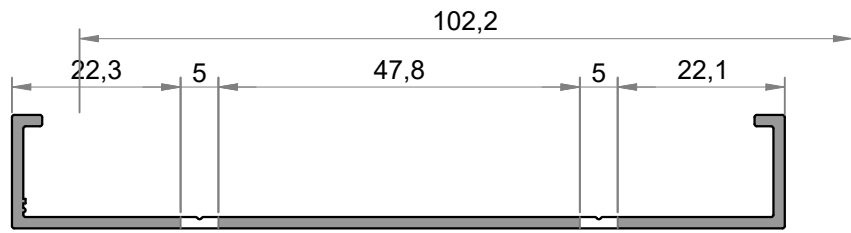

Todas as informações são de propriedades da Olgacolor e estão sujeitas a alterações sem aviso prévio.

GSK052

Marco Lateral 3 Planos
para Vidro Colado

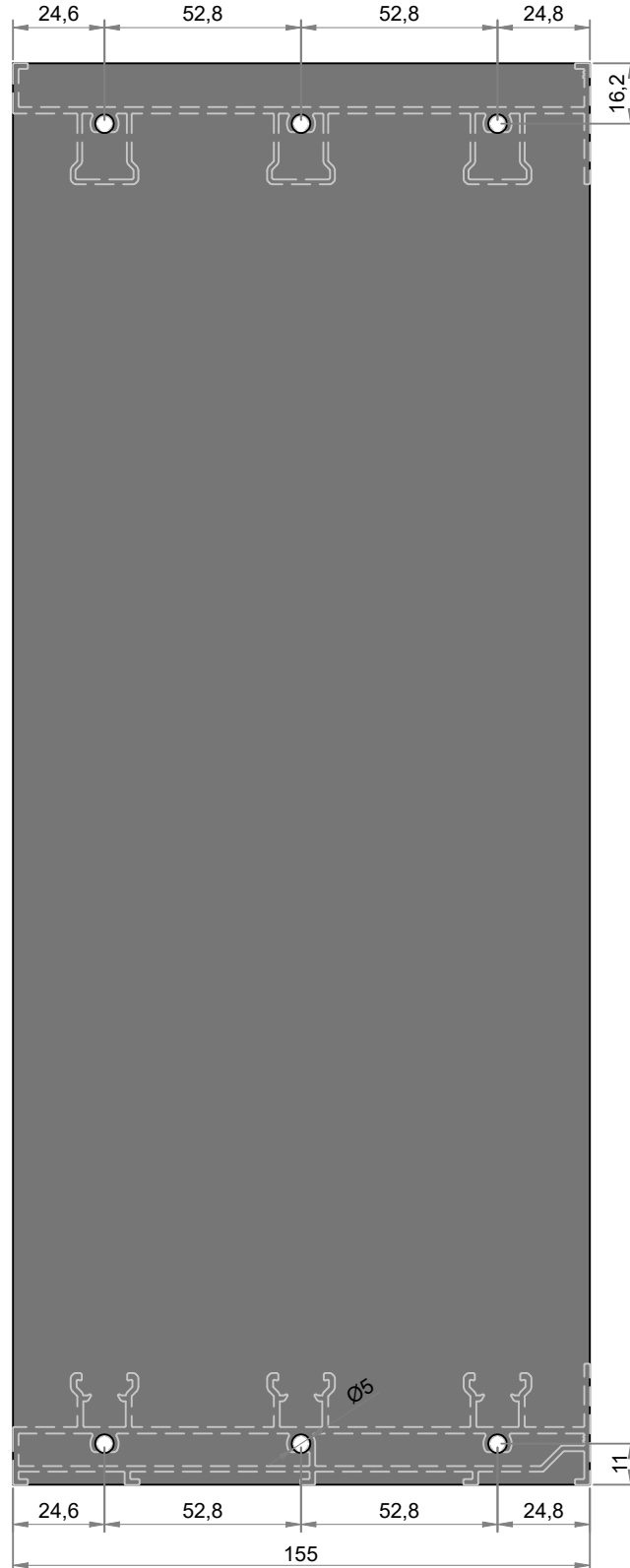
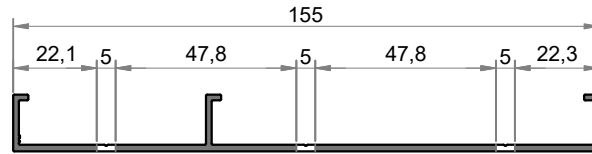

Todas as informações são de propriedades da Olgacolor e estão sujeitas a alterações sem aviso prévio.

GSK004

Mata Junta lateral

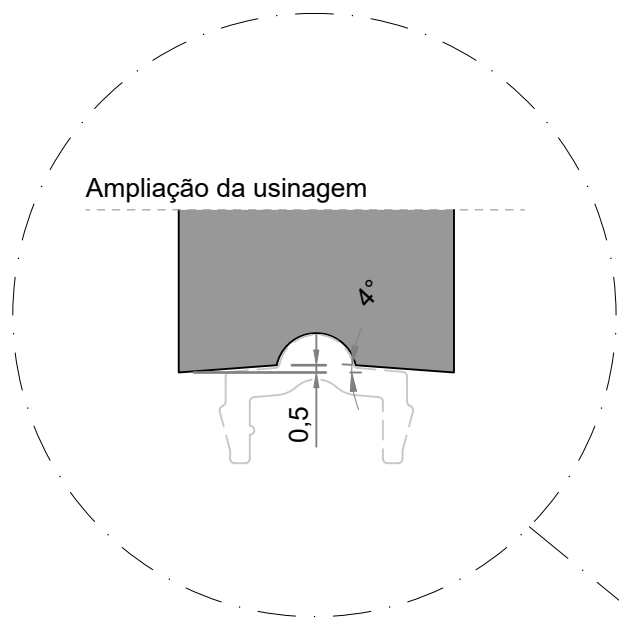
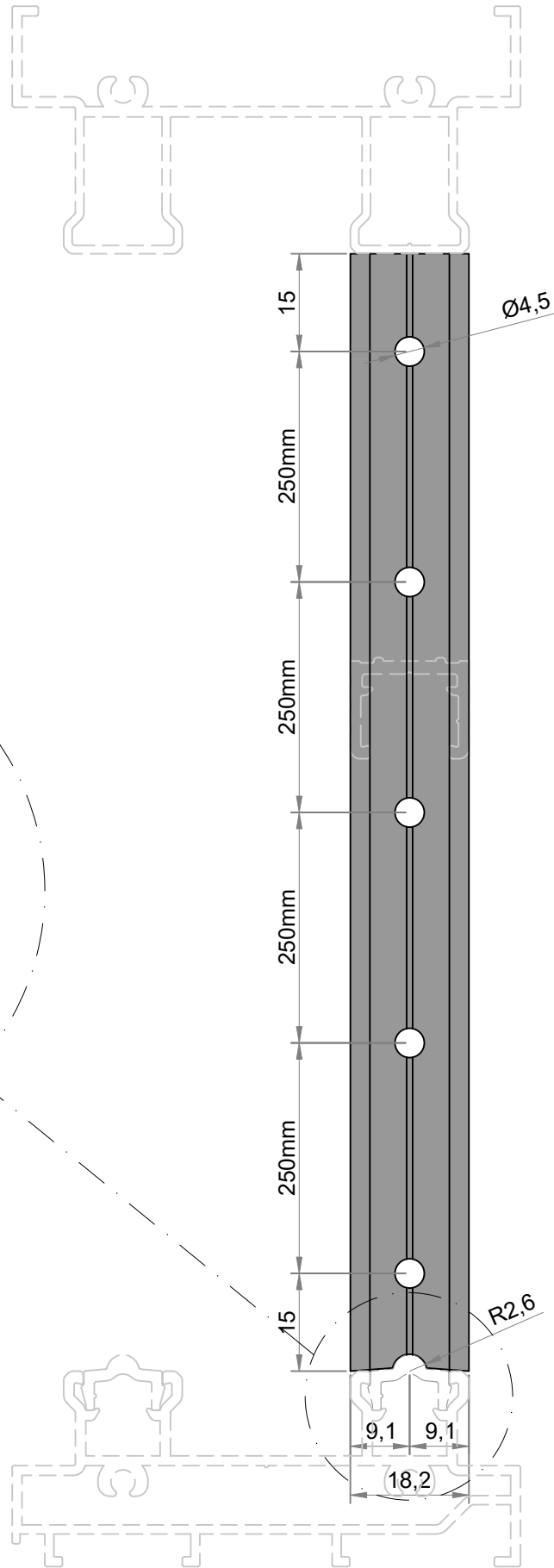
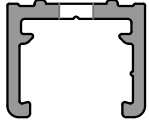

GSK012

Mata Junta central

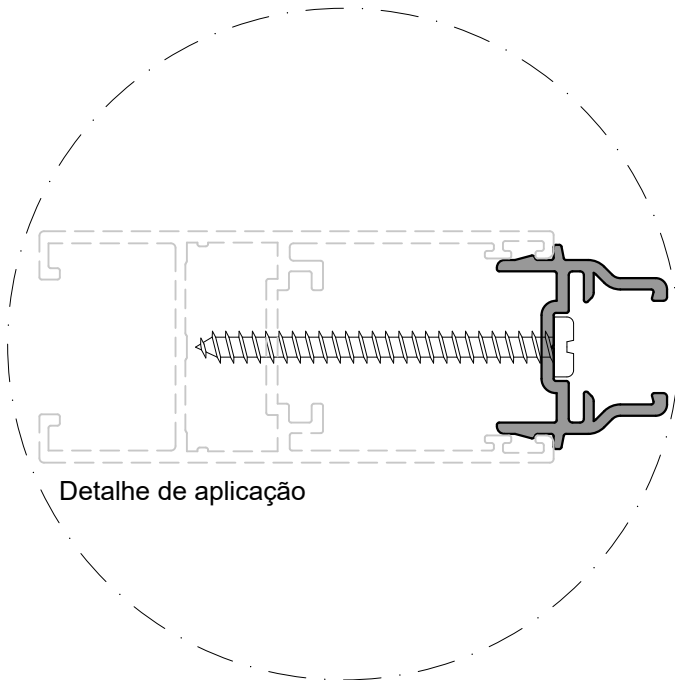
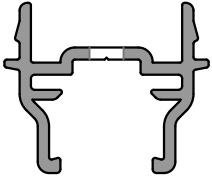

Detalhe de aplicação

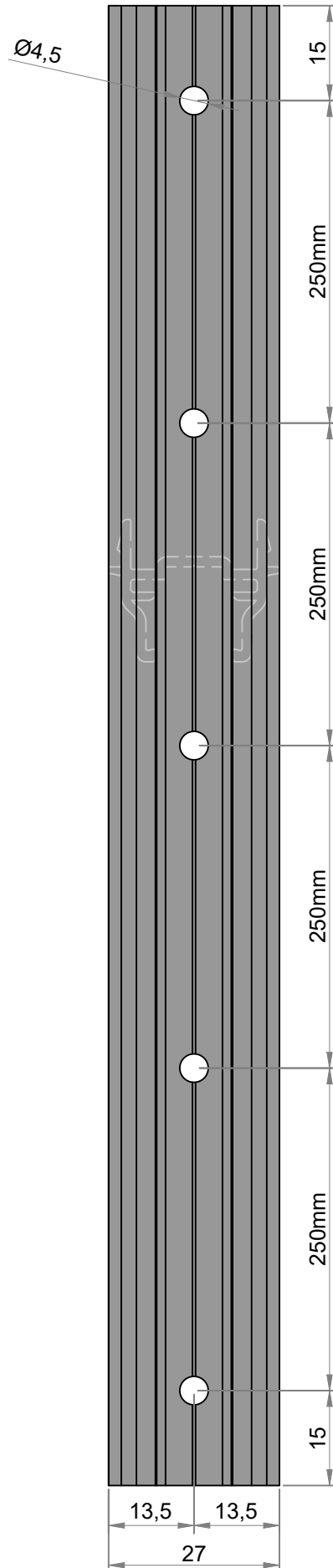

Todas as informações são de propriedades da Olgacolor e estão sujeitas a alterações sem aviso prévio.

GSK006

Pingadeira e barreira de
condensação

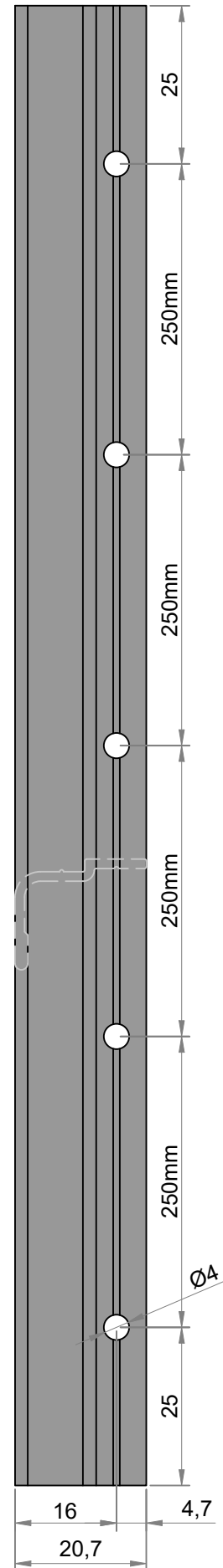
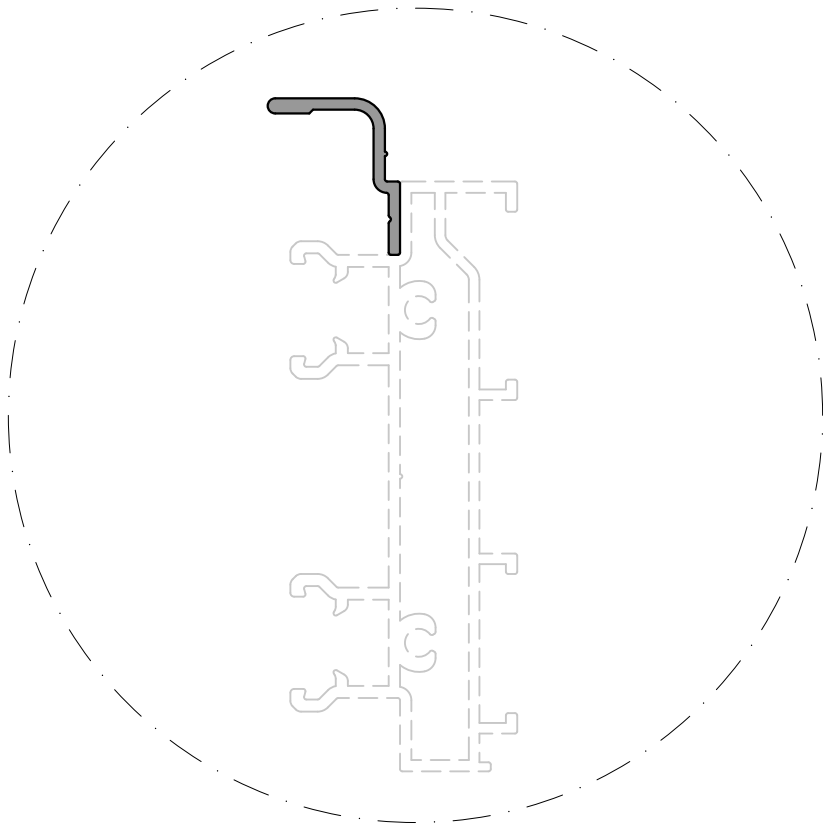
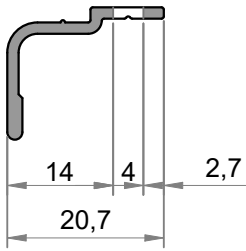

Todas as informações são de propriedades da Olgacolor e estão sujeitas a alterações sem aviso prévio.

GSK024

Folha

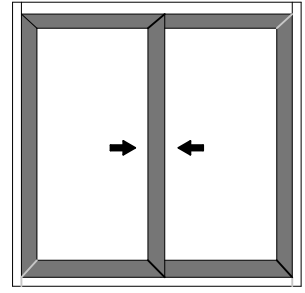
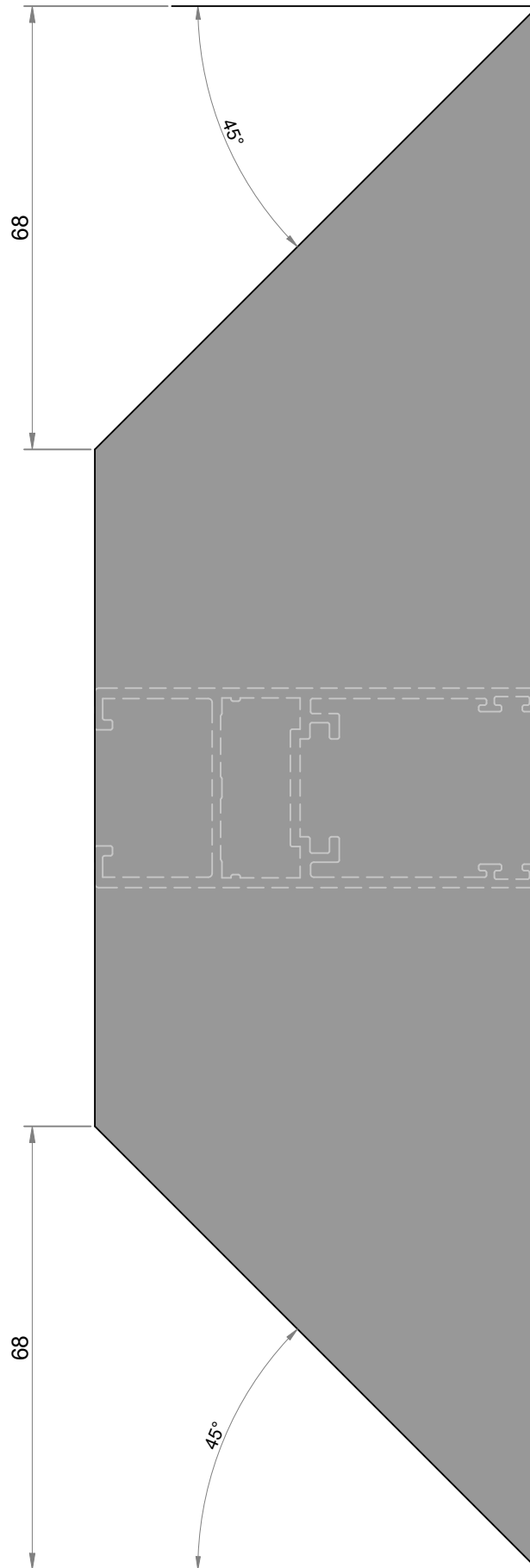
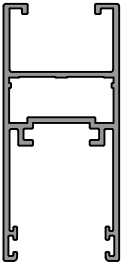

GSK024

Montante lateral e mão
de amigo

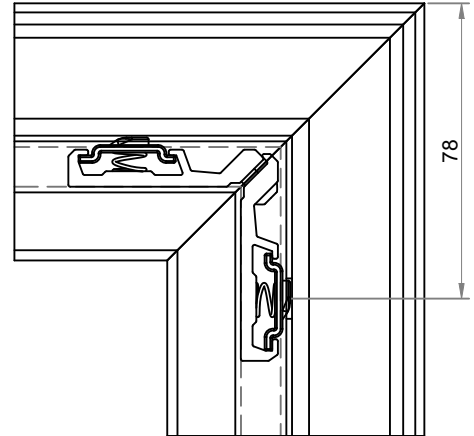
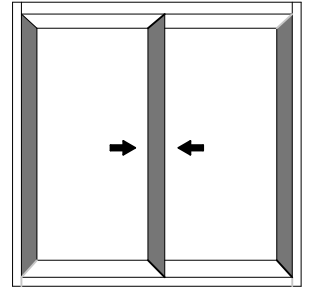
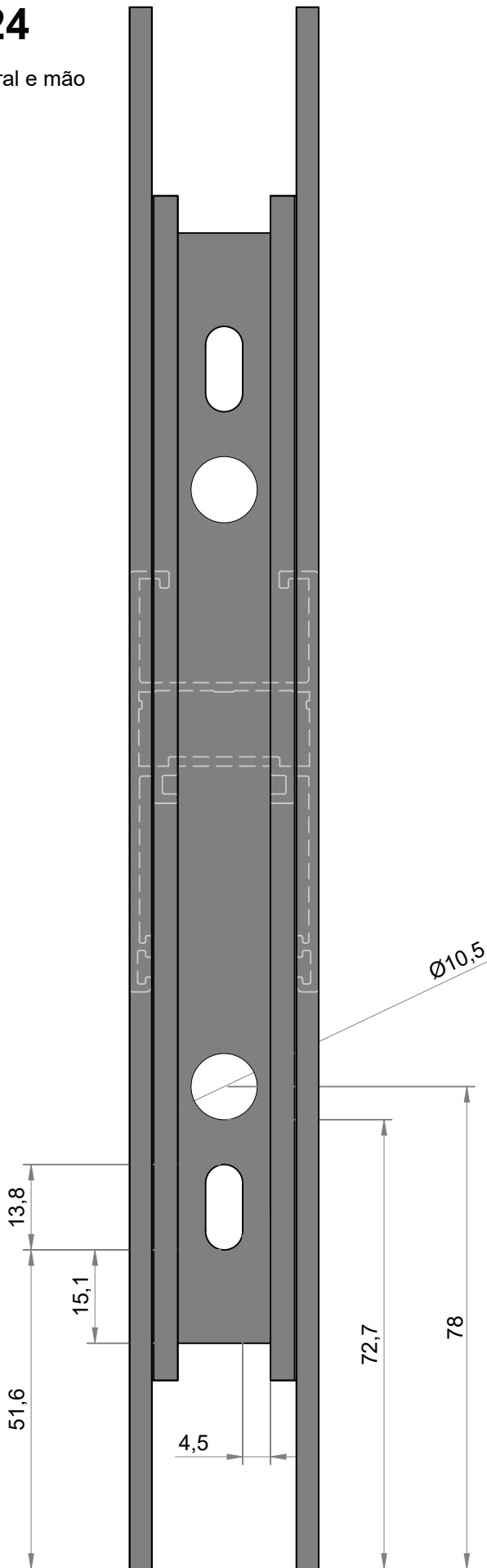
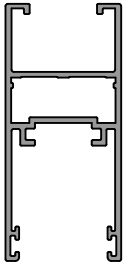

Todas as informações são de propriedades da Olgacolor e estão sujeitas a alterações sem aviso prévio.

GSK024

Travessa superior
e inferior

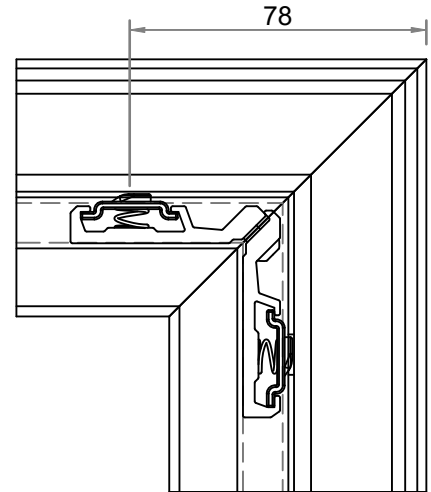
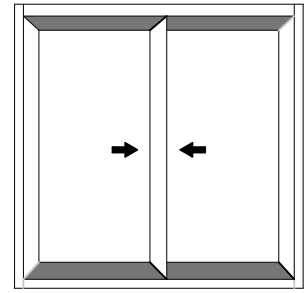
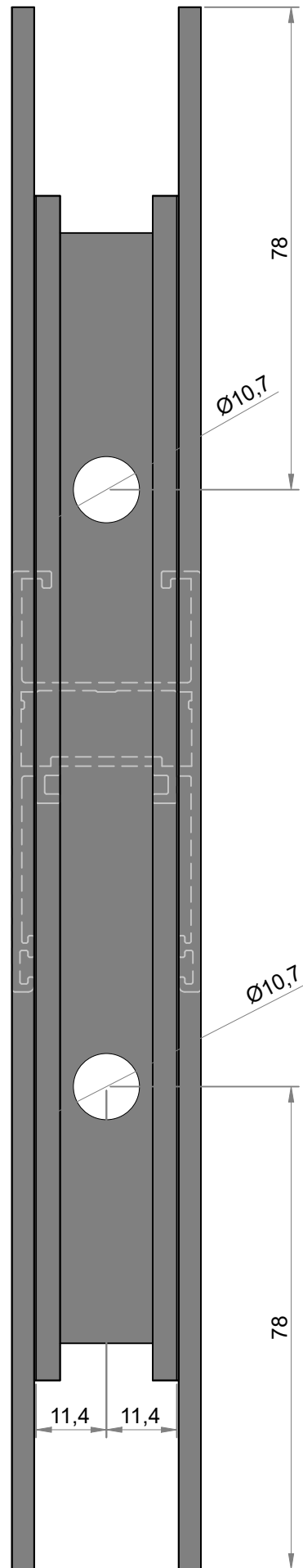
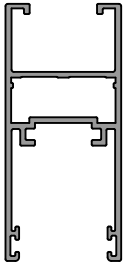

GSK024

Travessa para montante
minimalista

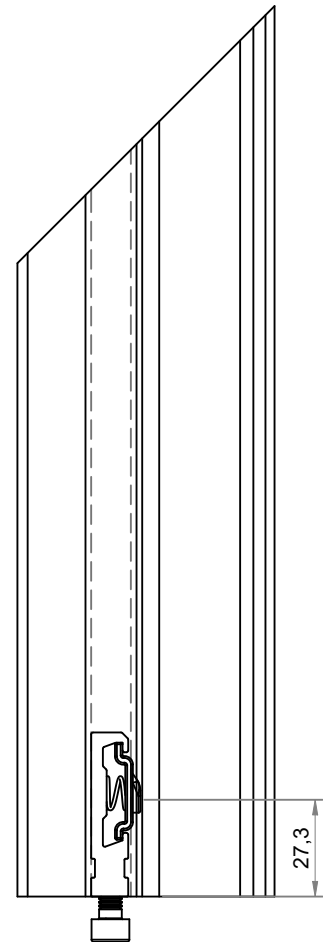
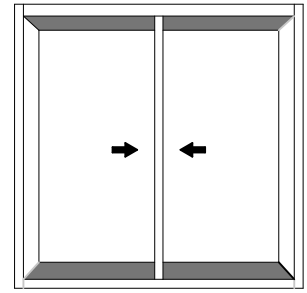
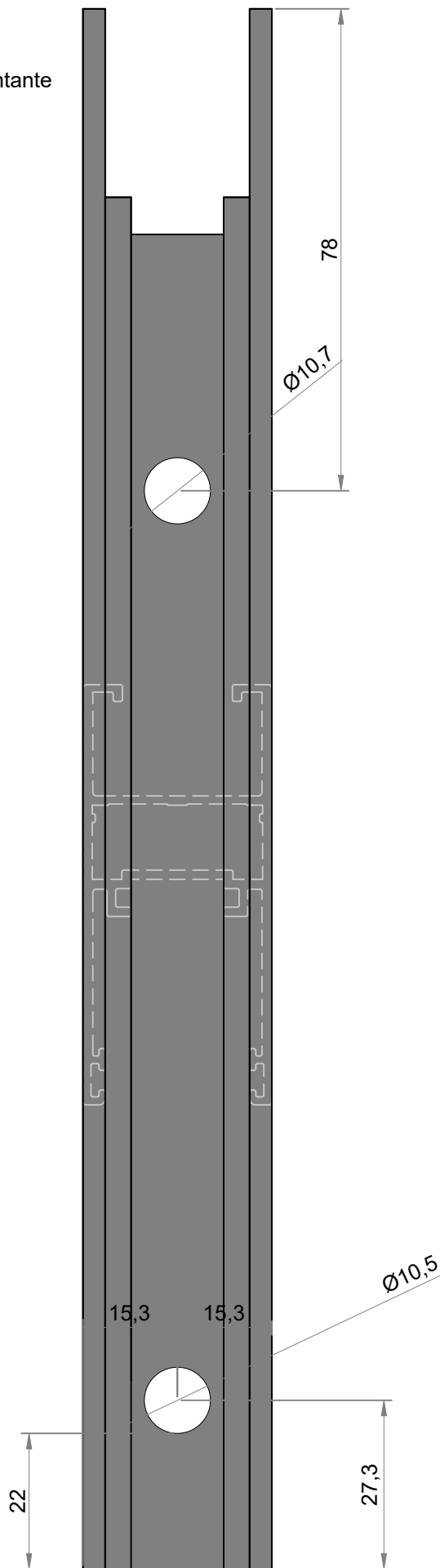
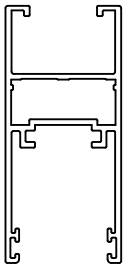

Todas as informações são de propriedades da Olgacolor e estão sujeitas a alterações sem aviso prévio.

GSK027

Montante minimalista

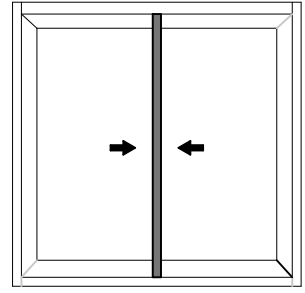
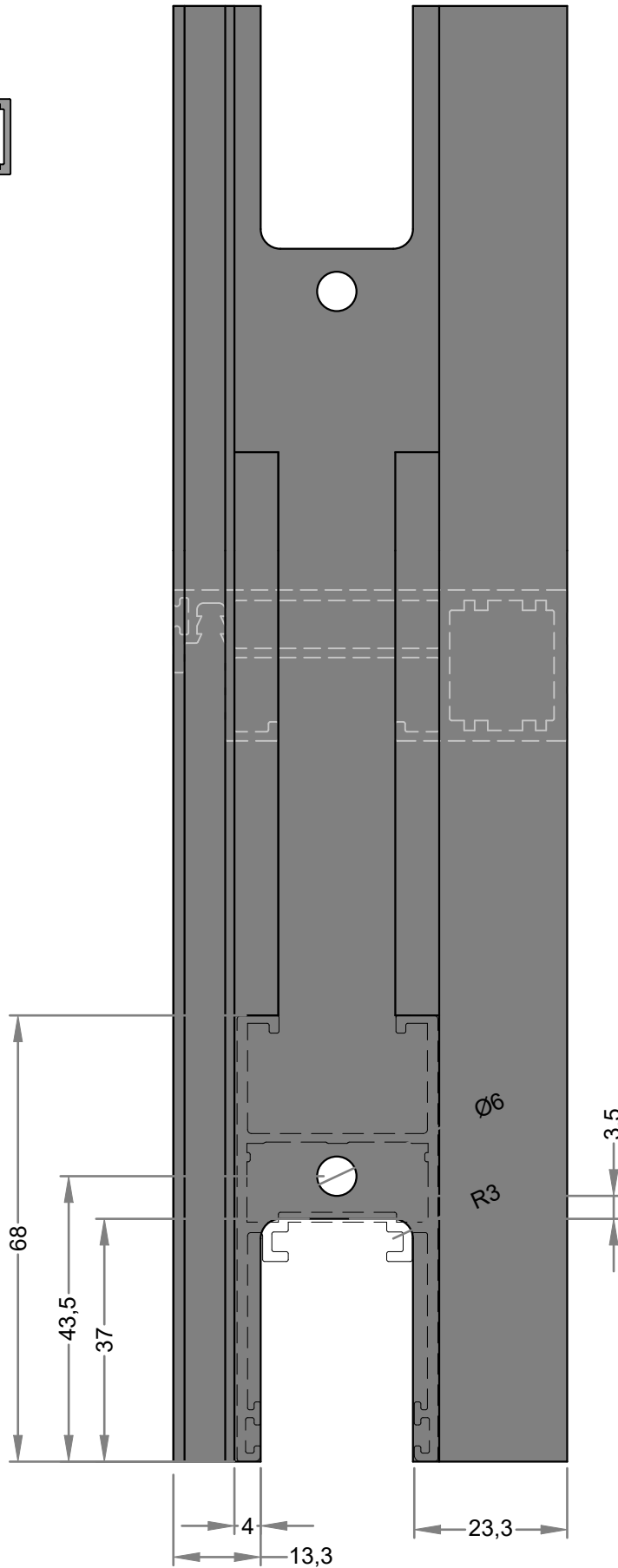
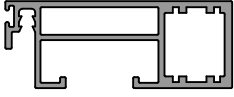

GSK027

Montante minimalista

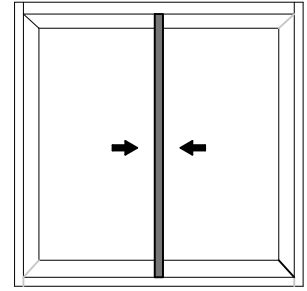
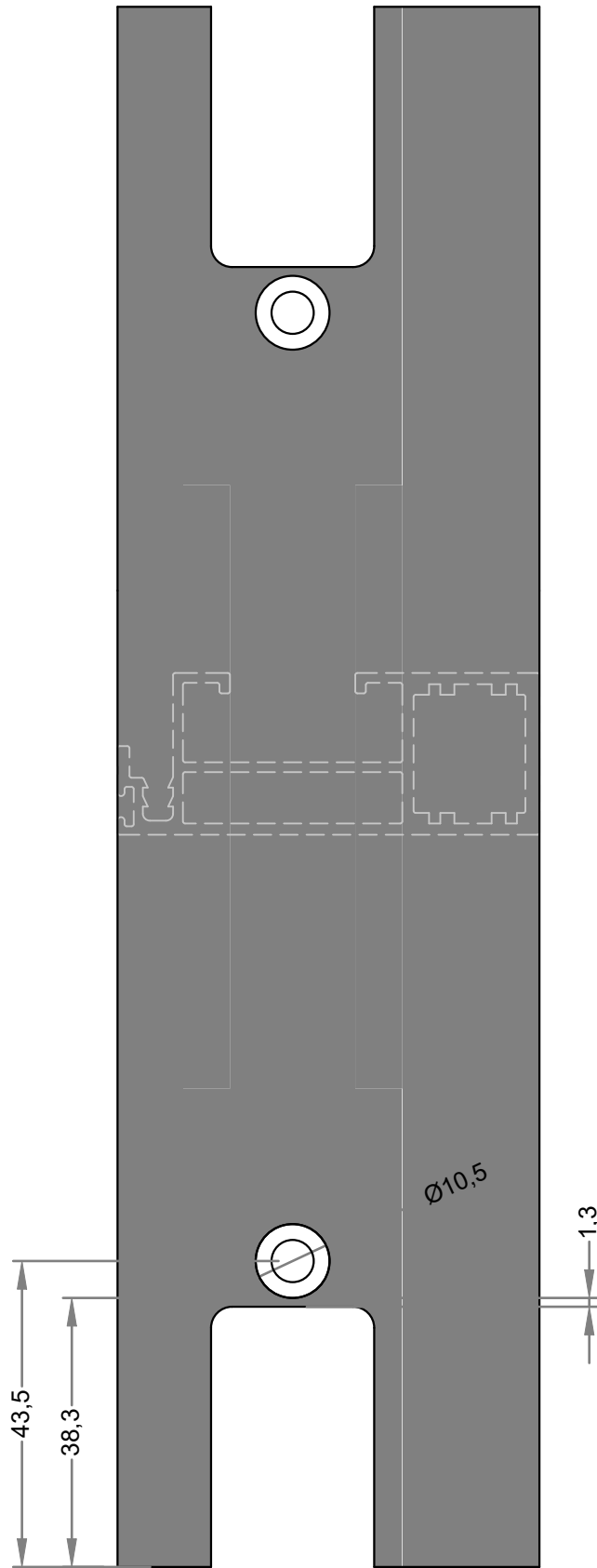

GSK043

Travessa / Montante

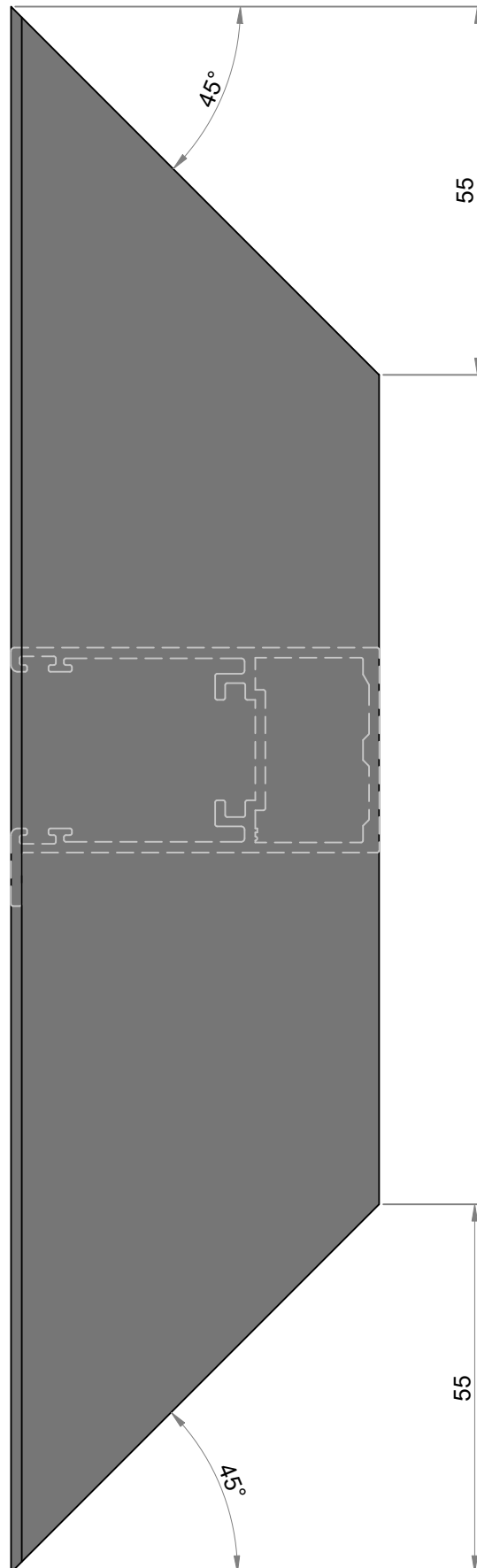
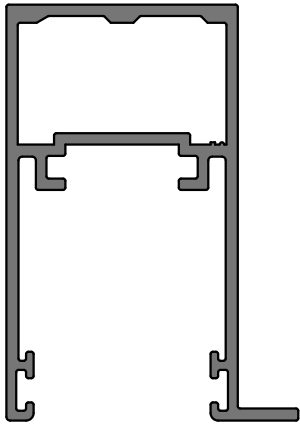

GSK043

Travessa / Montante

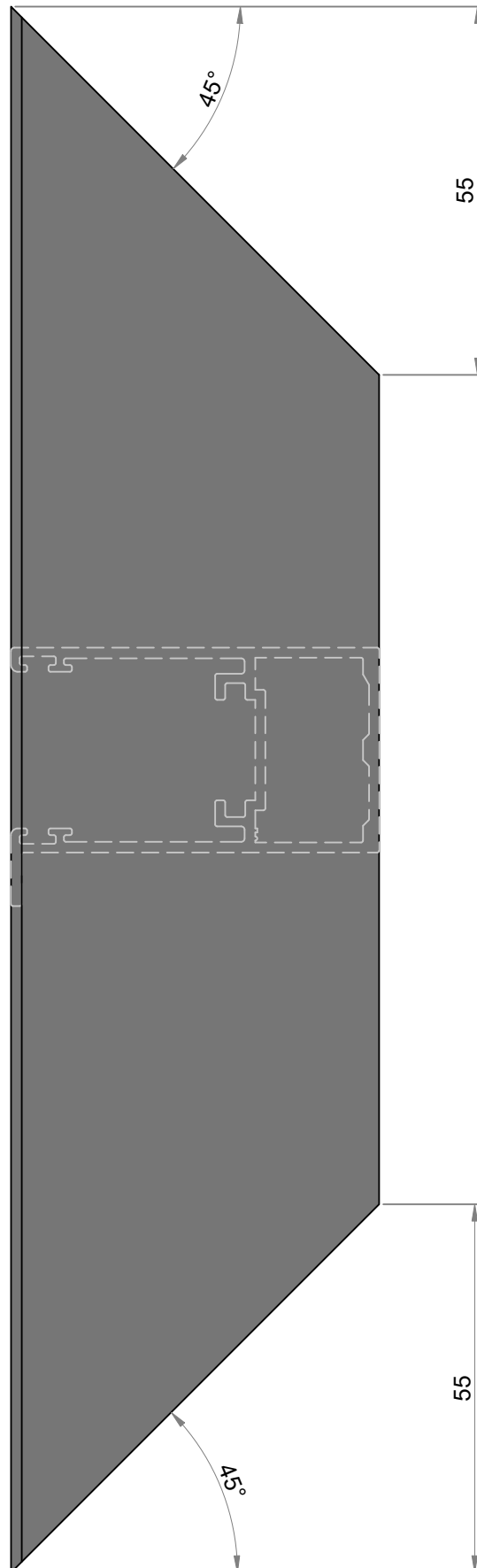
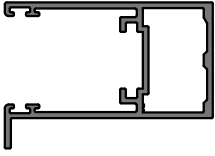

Todas as informações são de propriedades da Olgacolor e estão sujeitas a alterações sem aviso prévio.

GSK043

Montante

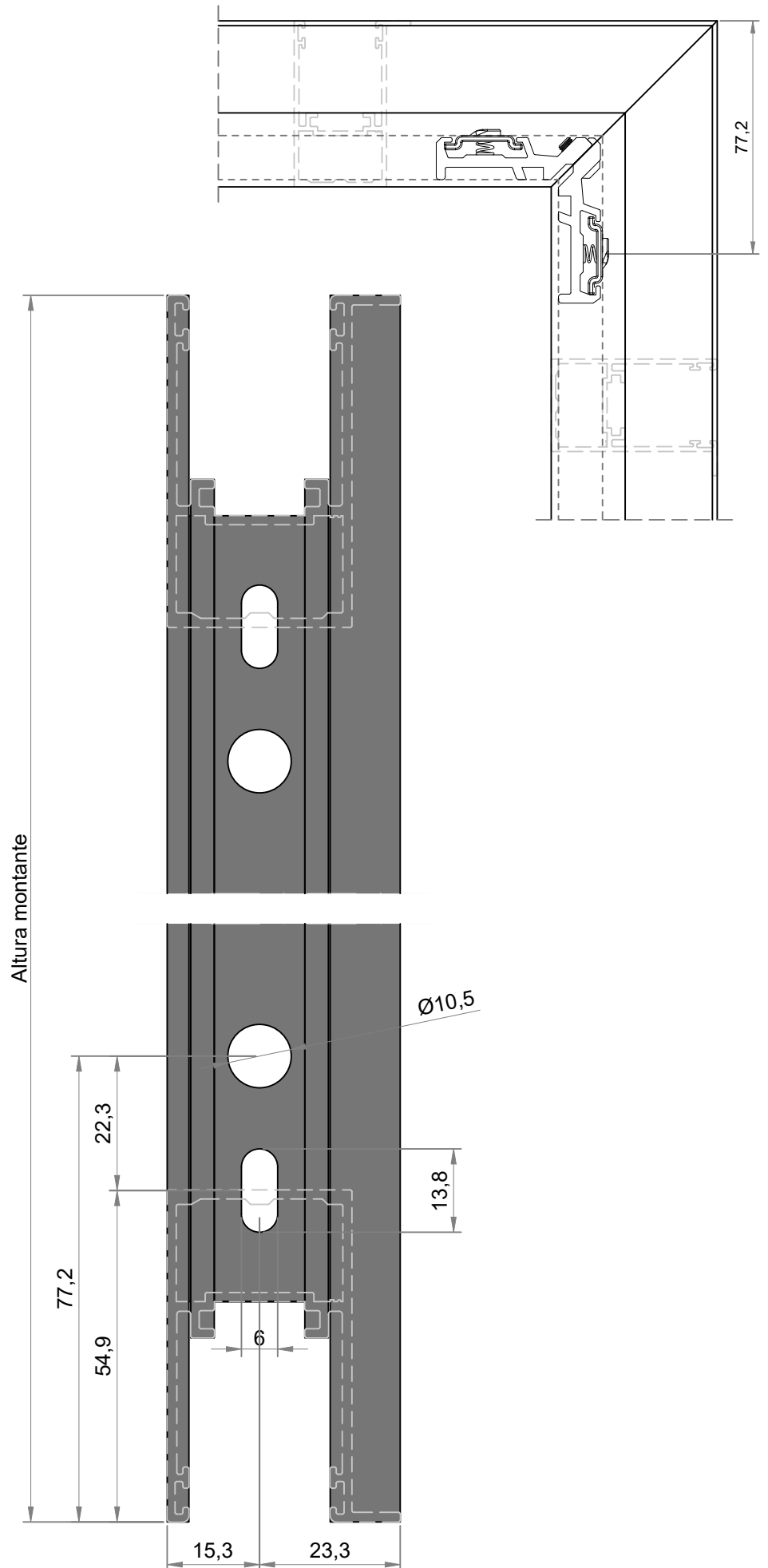
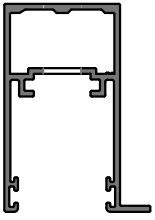

Todas as informações são de propriedades da Olgacolor e estão sujeitas a alterações sem aviso prévio.

GSK043

Travessa

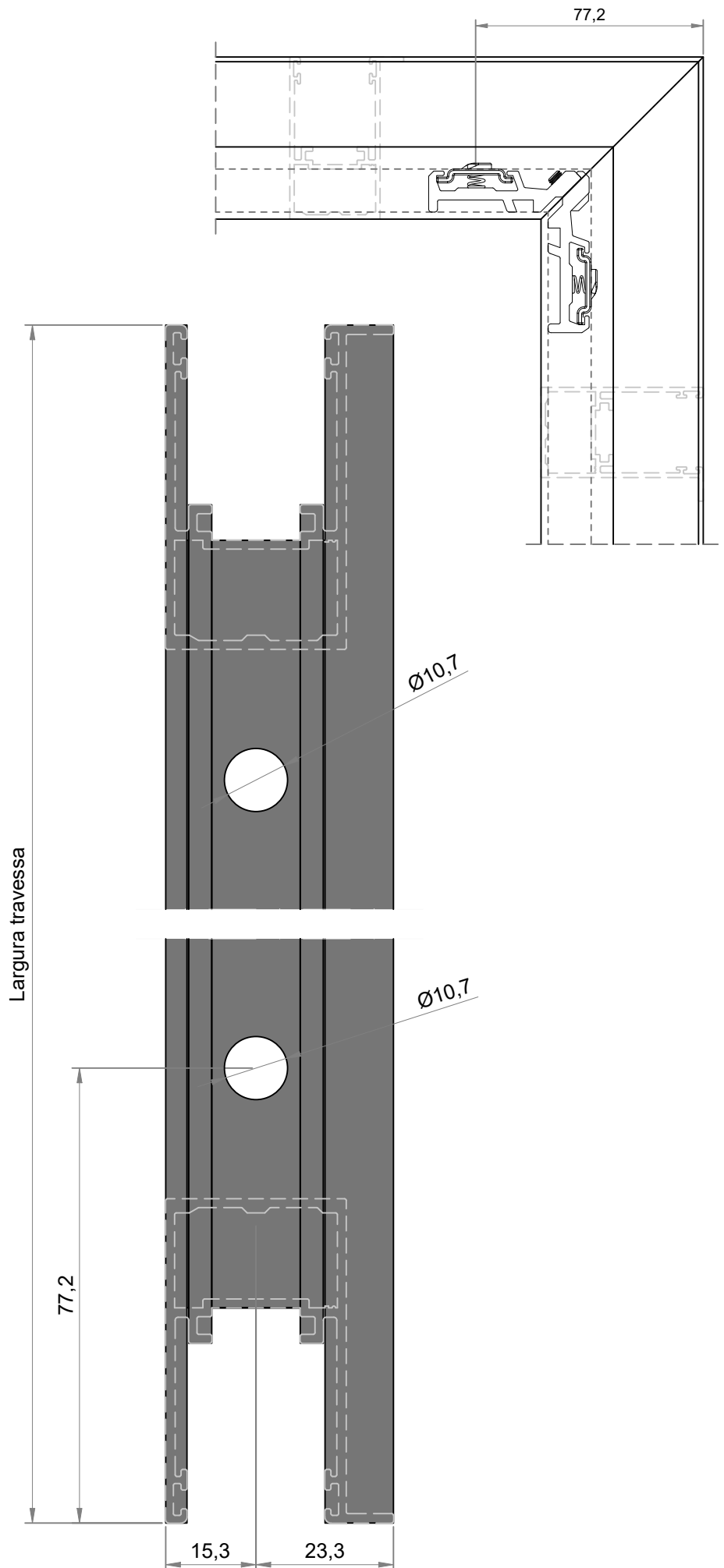
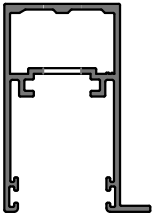

Todas as informações são de propriedades da Olgacolor e estão sujeitas a alterações sem aviso prévio.

GSK047

Reforço para montante

